

RM741

General Purpose Operational Amplifier

Description

The RM741 integrated circuit is a high-performance, high-gain, internally compensated monolithic operational amplifier fabricated on a single silicon chip using an advanced epitaxial process.

High common-mode voltage range and absence of latch-up tendencies make the RM741 ideal for use as a voltage follower. High gain and wide ranges of operating voltages provide superior performance in integrator, summing amplifier and general feedback applications.

The RM741 is pin compatible with the LM101A. The RM741 operates over a temperature range from -55°C to +125°C.

Features

- ◆ Supply voltage
RM741 — $\pm 22V$
- ◆ Offset voltage null capability
- ◆ Short-circuit protection
- ◆ No frequency compensation required
- ◆ No latch-up
- ◆ Large common-mode and differential voltage ranges
- ◆ Low power consumption

RM741

Connection Information

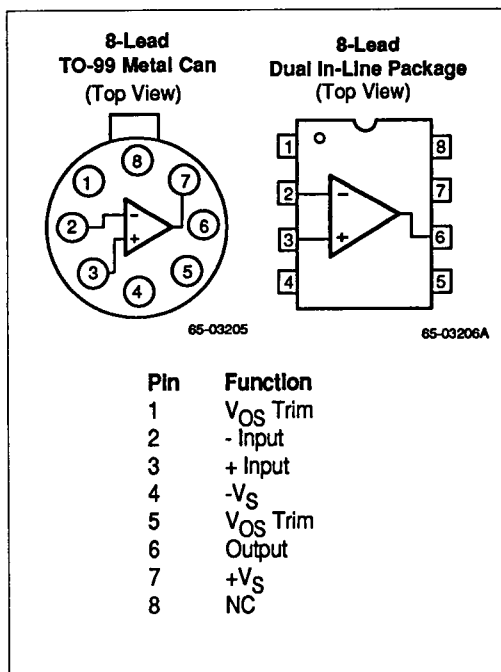

Ordering Information

Part Number	Package	Operating Temperature Range
RM741D	D	-55°C to +125°C
RM741D/883B	D	-55°C to +125°C
RM741T	T	-55°C to +125°C
RM741T/883B	T	-55°C to +125°C

Notes: 883B suffix denotes Mil-Std-883, Level B processing

D = 8 lead ceramic DIP

T = 8-lead metal can TO-99

Absolute Maximum Ratings

Supply Voltage

RM741 $\pm 22V$

Differential Input Voltage 30V

Input Voltage¹ $\pm 15V$

Output Short Circuit Duration .. Indefinite

Storage Temperature

Range -65°C to +150°C

Operating Temperature Range

RM741 -55°C to +125°C

Lead Soldering Temperature

(60 sec) +300°C

Note:

- For supply voltages less than $\pm 15V$, the absolute maximum input voltage is equal to the supply voltage.

Thermal Characteristics

	8-Lead Ceramic DIP	8-Lead TO-99 Metal Can
Max. Junction Temp.	+175°C	+175°C
Max. P_D $T_A < 50^\circ\text{C}$	833 mW	658 mW
Therm. Res θ_{JC}	45°C/W	50°C/W
Therm. Res. θ_{JA}	150°C/W	190°C/W
For $T_A > 50^\circ\text{C}$ Derate at	8.33 mW/°C	5.26 mW/°C

Electrical Characteristics

($V_S = \pm 15\text{V}$ and $T_A = +25^\circ\text{C}$ unless otherwise noted)

Parameters	Test Conditions	Min	Typ	Max	Units
Input Offset Voltage ¹	$R_S \leq 10\text{ k}\Omega$		1.0	5.0	mV
Input Offset Current			20	200	nA
Input Bias Current			80	500	nA
Input Resistance (Differential Mode)		0.3	2.0		M Ω
Large Signal Voltage Gain	$R_I \geq 2\text{ k}\Omega$, $V_{OUT} = \pm 10\text{V}$	50	200		V/mV
Output Voltage Swing	$R_I \geq 10\text{ k}\Omega$	± 12	± 14		V
	$R_I \geq 2\text{ k}\Omega$	± 10	± 13		
Input Voltage Range		± 12	± 13		V
Common Mode Rejection Ratio	$R_S \leq 10\text{ k}\Omega$	70	90		dB
Power Supply Rejection Ratio	$R_S \leq 10\text{ k}\Omega$	76	90		dB
Power Consumption			50	85	mW
Transient Response Rise Time	$V_{IN} = 20\text{ mV}$, $R_I = 2\text{ k}\Omega$		0.3		μs
Over shoot	$C_L \leq 100\text{ pF}$		5.0		%
Slew Rate	$R_I \geq 2\text{ k}\Omega$		0.5		V/ μs

Note: 1. Offset voltage is nulled by connecting a 10k Ω potentiometer across the Vos trim pins and connecting the wiper pin to $-V_S$.

RM741

Electrical Characteristics

($V_S = \pm 15V$, $-55^\circ C \leq T_A \leq +125^\circ C$)

Parameters	Test Conditions	Min	Typ	Max	Units
Input Offset Voltage	$R_L \geq 10\text{ k}\Omega$			6.0	mV
Input Offset Current				200	nA
Input Bias Current				500	nA
Large Signal Voltage Gain	$R_L \geq 2\text{ k}\Omega$, $V_{OUT} = \pm 10V$	25			V/mV
Output Voltage Swing	$R_L \geq 10\text{ k}\Omega$		± 12		V
	$R_L \geq 2\text{ k}\Omega$		± 10		
Common Mode Rejection Ratio	$R_S \leq 10\text{ k}\Omega$		70		dB
Supply Voltage Rejection Ratio	$R_S \leq 10\text{ k}\Omega$		76		dB
Supply Current	+125°C				mA
	-55°C				
Power Consumption	+125°C				mW
	-55°C				

Typical Performance Characteristics

Input Offset Voltage Trim Circuit

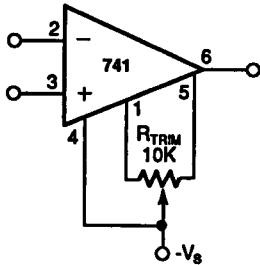

65-0047

Transient Response Test Circuit

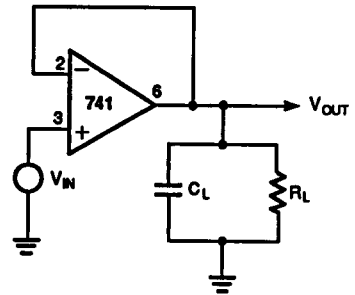

65-0048

Power Consumption vs. Supply Voltage

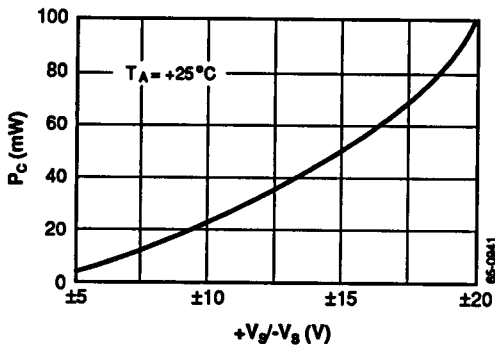

65-0041

Open Loop Gain Vs. Frequency

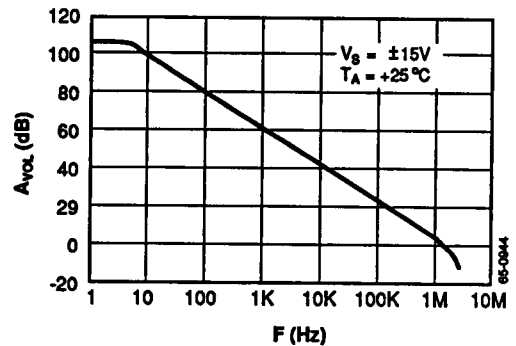

65-0044

Open Loop Phase vs. Frequency

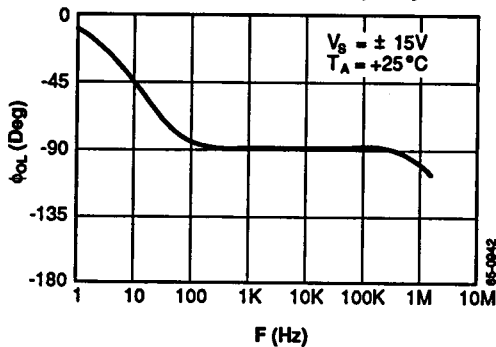

65-0042

Input Offset Current vs. Supply Voltage

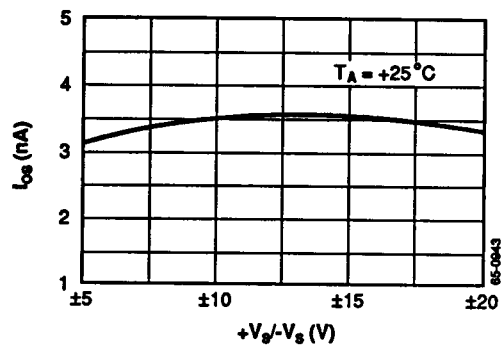

65-0043

Linear

RM741

Typical Performance Characteristics (Continued)

Input Resistance, Capacitance vs. Frequency

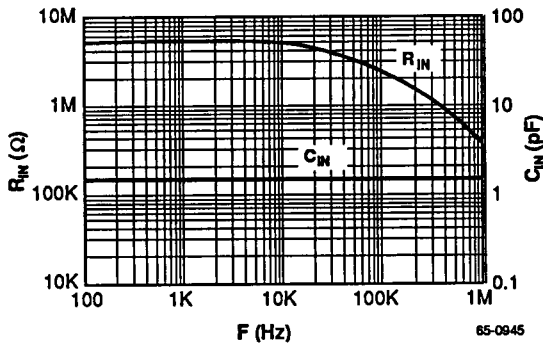

Output Resistance vs. Frequency

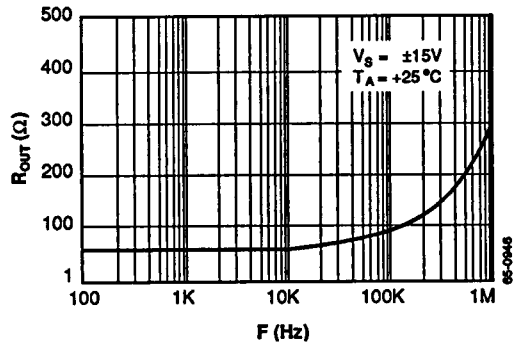

Output Voltage Swing vs. Load Resistance

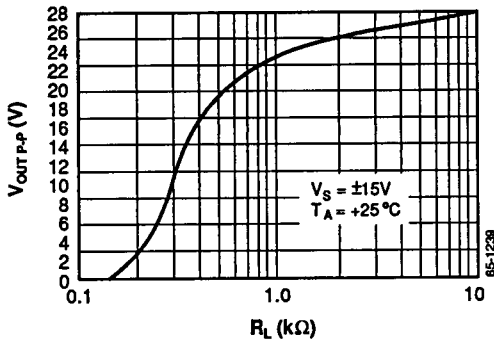

Output Voltage Swing vs. Frequency

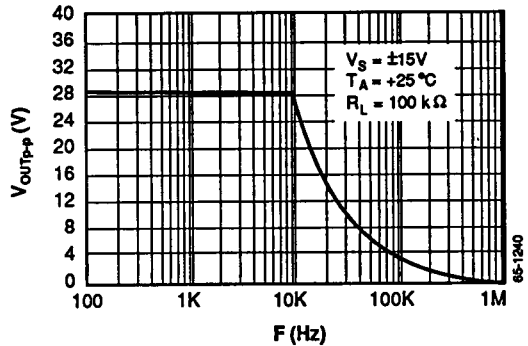

Input Noise Voltage Density vs. Frequency

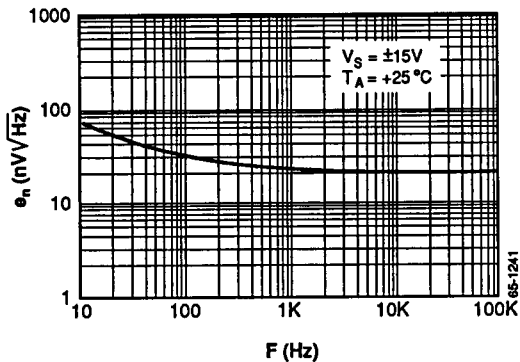

Input Noise Current Density vs. Frequency

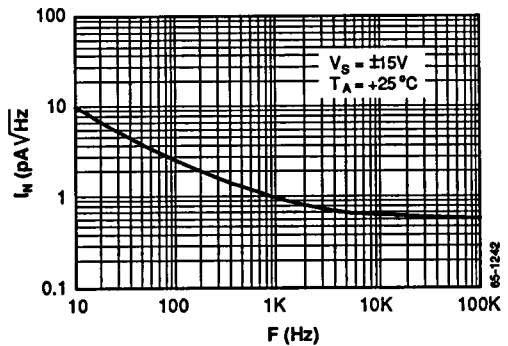

Typical Performance Characteristics (Continued)

Input Bias Current vs. Temperature

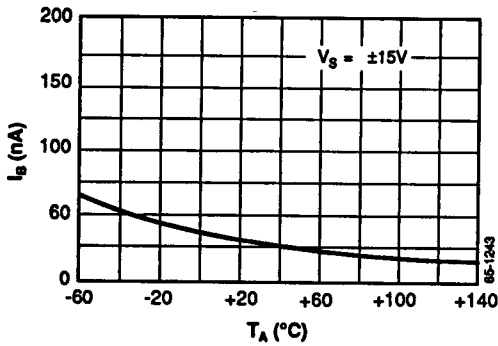

Short Circuit Current vs. Temperature

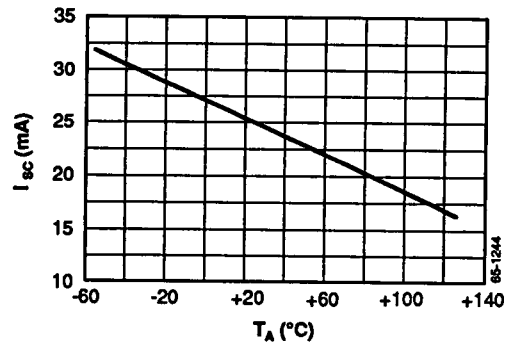

Input Offset Current vs. Temperature

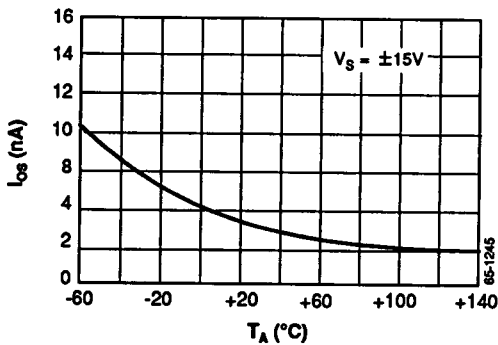

Power Consumption vs. Temperature

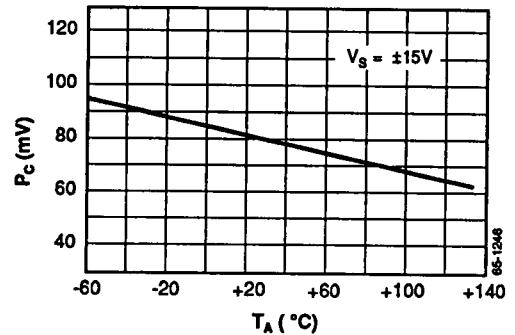

Frequency Characteristics vs. Temperature

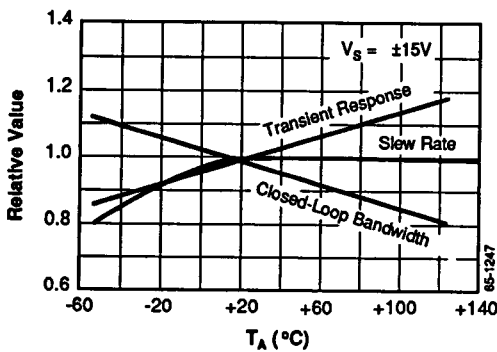

Open Loop Gain vs. Supply Voltage

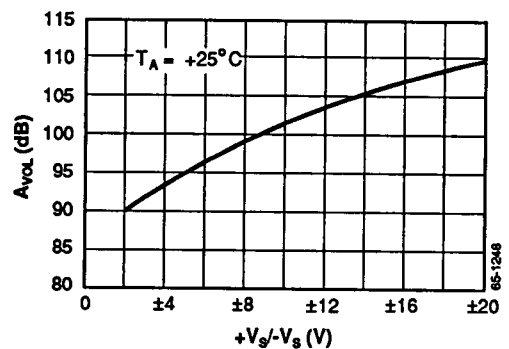

Linear

RM741

Typical Performance Characteristics (Continued)

Output Voltage Swing vs. Supply Voltage

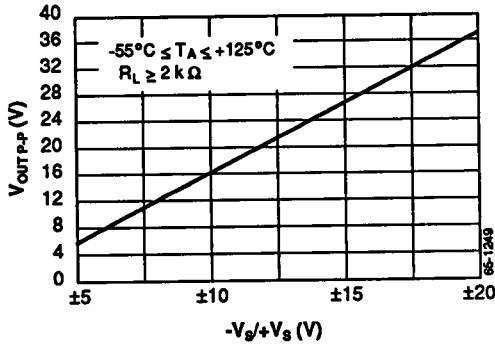

Common Mode Input Range vs. Supply Voltage

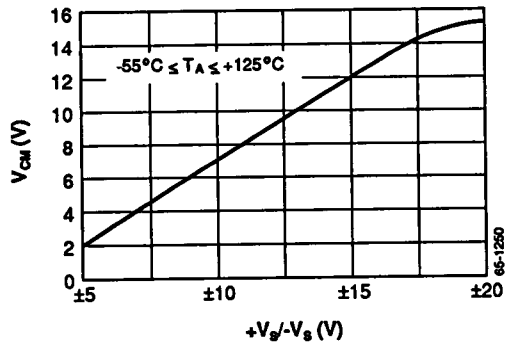

Schematic Diagram

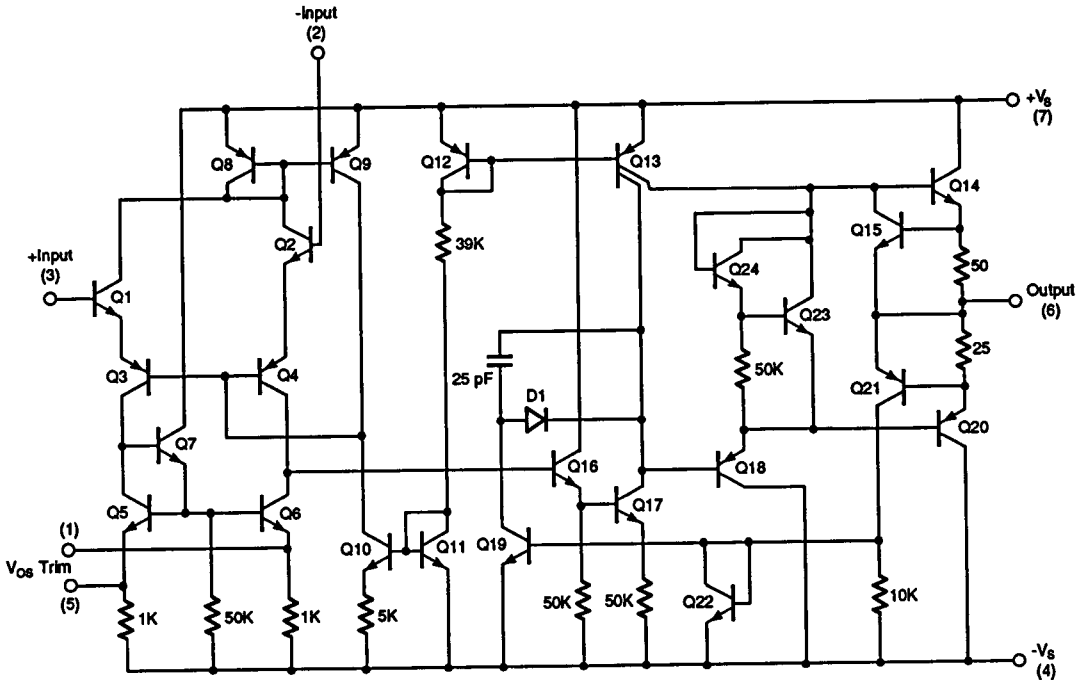

Note: All resistance and capacitance values are nominal.