

RC4741

General Purpose Operational Amplifier

Description

The RC4741 is a monolithic integrated circuit, consisting of four independent operational amplifiers constructed with the planar epitaxial process.

These amplifiers feature AC and DC performance which exceed that of the 741 type amplifiers. Its superior bandwidth, slew rate and noise characteristics make it an excellent choice for active filter or audio amplifier applications.

A wide range of supply voltages ($\pm 2V$ to $\pm 20V$) can be used to power the RC4741, making it compatible with almost any system including battery powered equipment.

Features

- ◆ Unity gain bandwidth — 3.5 MHz
- ◆ High slew rate — 1.6 V/ μ S
- ◆ Low noise voltage — 9 nV/ $\sqrt{\text{Hz}}$
- ◆ Input offset voltage — 0.5 mV
- ◆ Input bias current — 60 nA
- ◆ Indefinite short circuit protection
- ◆ No crossover distortion
- ◆ Internal compensation
- ◆ Wide power supply range — $\pm 2V$ to $\pm 20V$

Applications

- ◆ Universal active filters
- ◆ Audio amplifiers
- ◆ Battery powered equipment

RC4741

Connection Information

14-Lead Dual In-Line Package
(Top View)

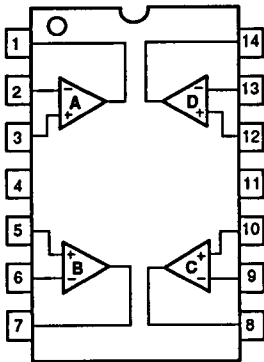

65-0418

Pin Function

- 1 Output (A)
- 2 -Input (A)
- 3 + Input (A)
- 4 +Vs
- 5 +Input (B)
- 6 -Input (B)
- 7 Output (B)
- 8 Output (C)
- 9 -Input (C)
- 10 +Input (C)
- 11 -Vs
- 12 +Input (D)
- 13 -Input (D)
- 14 Output (D)

Ordering Information

Part Number	Package	Operating Temperature Range
RC4741M	M	0°C to +70°C
RC4741N	N	0°C to +70°C
RM4741D	D	-55°C to +125°C
RM4741D/883B	D	-55°C to +125°C

Notes:

/883B suffix denotes Mil-Std-883, Level B processing

N = 14-lead plastic DIP

D = 14-lead ceramic DIP

M = 14-lead small outline

Absolute Maximum Ratings

Supply Voltage	±20V
Differential Input Voltage	30V
Input Voltage ¹	±15V
Output Short Circuit	
Duration ²	Indefinite
Storage Temperature	
Range	-65°C to +150°C
Operating Temperature Range	
RM4741	-55°C to +125°C
RC4741	0°C to +70°C
Lead Soldering Temperature	
(60 Sec, DIP)	+300°C
(10 Sec, SOIC)	+260°C

Notes:

- For supply voltages less than ±15V, the absolute maximum input voltage is equal to the supply voltage.
- Short circuit to ground on one amplifier only.

Thermal Characteristics

	14-Lead Small Outline	14-Lead Plastic DIP	14-Lead Ceramic DIP
Max. Junction Temp	+125°C	+125°C	+175°C
Max. P_D $T_A=50^\circ\text{C}$	300 mW	468 mW	1042 mW
Therm. Res. θ_{JC}	-	-	60°C/W
Therm Res. θ_{JC}	200°C/W	160°C/W	120°C/W
For $T_A > 50^\circ\text{C}$ Derate at	5.0 mW/°C	6.25 mW/°C	8.38 mW/°C

Electrical Characteristics

($V_S = \pm 15\text{V}$ and $T_A = 25^\circ\text{C}$ unless otherwise specified)

Parameters	Test Conditions	RM4741			RC4741			Units
		Min	Typ	Max	Min	Typ	Max	
Input Offset Voltage	$R_S \leq 10\text{k}\Omega$		0.5	3.0		1.0	5.0	mV
Input Offset Current			15	30		30	50	nA
Input Bias Current			60	200		60	300	nA
Input Resistance			0.5			0.5		M Ω
Large Signal Voltage Gain	$R_L \geq 2\text{k}\Omega$ $V_{OUT} \pm 10\text{V}$	50	100		25	50		V/mV
Input Voltage Range		± 12			± 12			V
Output Resistance			300			300		Ω
Output Current	$V_{OUT} \pm 10\text{V}$	± 5	± 15		± 5	± 15		mA
Common Mode Rejection Ratio	$R_S \leq 10\text{k}\Omega$ $\Delta V = \pm 5$	80			80			dB
Supply Current (All Amplifiers)			4.5	5.0		5.0	7.0	mA
Transient Response								
Rise Time			75			75		nS
Overshoot			25			25		%
Slew Rate			1.6			1.6		V/ μS
Unity Gain Bandwidth			3.5			3.5		MHz
Power Bandwidth	$V_{OUT} = 20\text{Vp-p}$ $R_L = 2\text{k}$		25			25		kHz
Input Noise Voltage Density	$F = 1\text{kHz}$		9.0			9.0		nV/ $\sqrt{\text{Hz}}$
Channel Separation			108			108		dB

Linear

RC4741

Electrical Characteristics

($V_S = \pm 15V$, $R_M = -55^\circ C \leq T_A \leq +125^\circ C$, $R_C = 0^\circ C \leq T_A + 70^\circ C$)

Parameters	Test Conditions	RM4741			RC4741			Units
		Min	Typ	Max	Min	Typ	Max	
Input Offset Voltage	$R_S \leq 10k\Omega$		4.0	5.0		5.0	6.5	mV
Input Offset Current				75			100	nA
Input Bias Current				325			400	nA
Large Signal Voltage Gain	$R_L \geq 2k\Omega$ $V_{OUT} \pm 10V$	25			15			V/mV
Output Voltage Swing	$R_L \geq 10k\Omega$	± 12	± 13.7		± 12	± 13.7		V
	$R_L \geq 2k\Omega$	± 10	± 12.5		± 10	± 12.5		
Supply Current (All Amplifiers)			10			10		mA
Average Input Offset Voltage Drift			5.0			5.0		$\mu V/^\circ C$
Common Mode Rejection Ratio	$R_S \leq 10k\Omega$ $\Delta V \pm 5.0V$	74			74			dB
Power Supply Rejection Ratio	$R_S \leq 10k\Omega$ $\Delta V \pm 5.0V$	80			80			dB

Typical Performance Characteristics

Open Loop Gain, Phase vs. Frequency

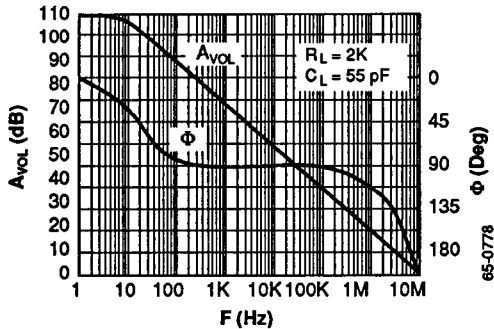

PSRR vs. Temperature

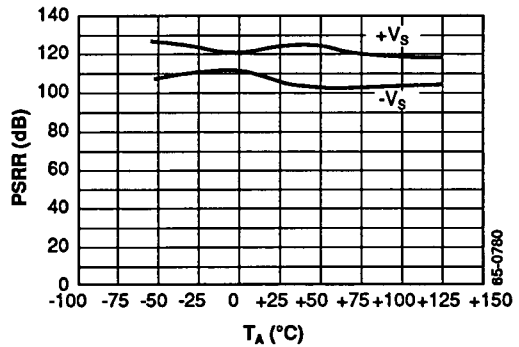

Typical Performance Characteristics (Continued)

Channel Separation vs. Frequency

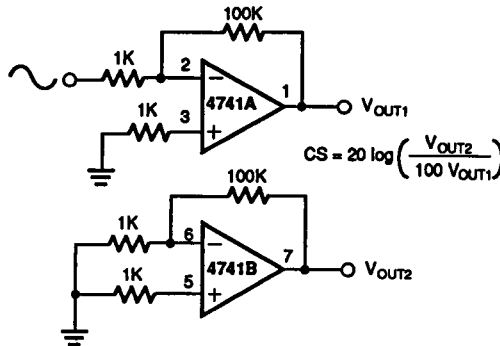
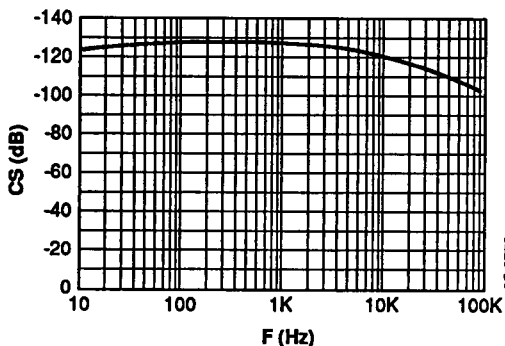

Transient Response vs. Temperature

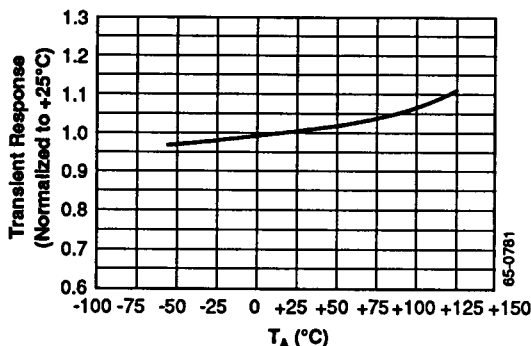

Input Noise Voltage vs. Frequency

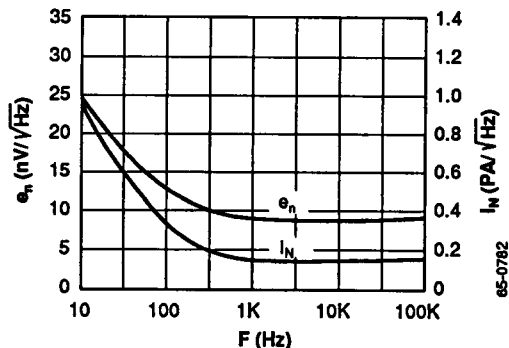

Slew Rate, Bandwidth vs. Temperature

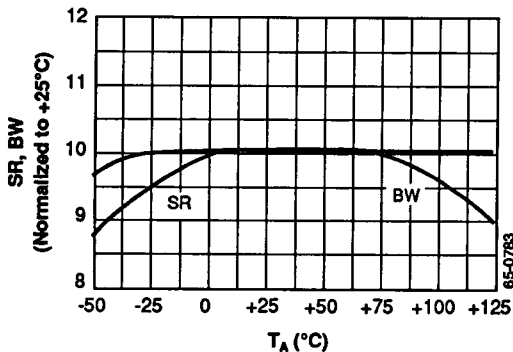

Slew Rate, Bandwidth vs. Supply Voltage

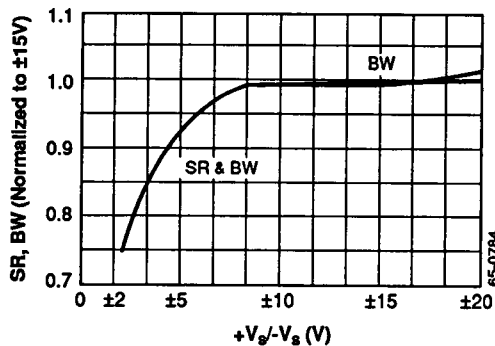

Linear

Typical Performance Characteristics (Continued)

Small Signal Phase Margin, Unity Gain Bandwidth vs. Load Capacitance

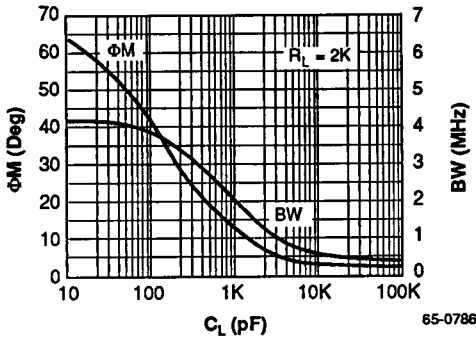

Output Voltage Swing vs. Frequency

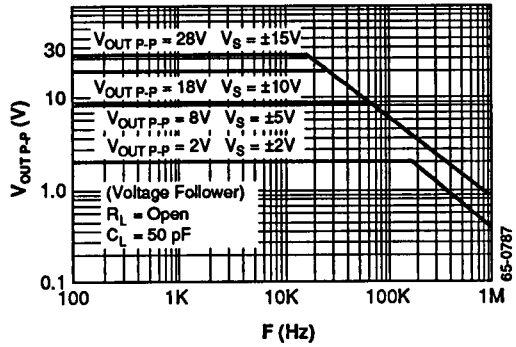

Input Bias, Offset Current vs. Temperature

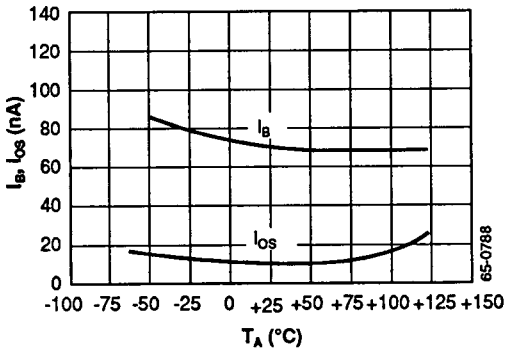

CMRR vs. Temperature

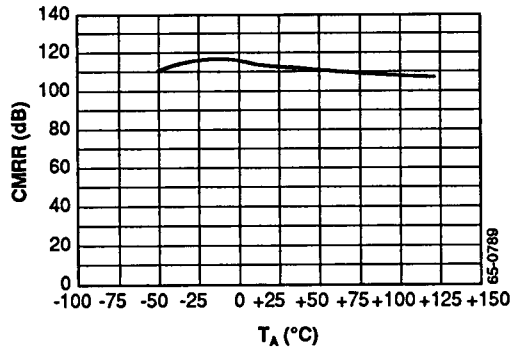

Output Voltage Swing vs. Load Resistance

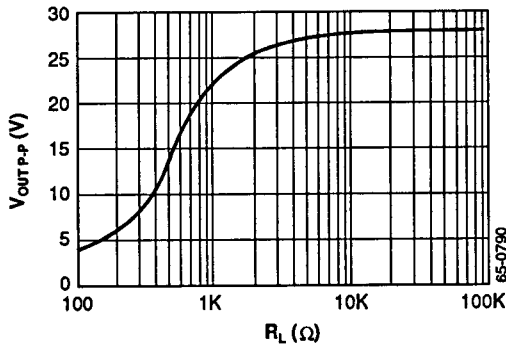

Schematic Diagram (1/4 Shown)

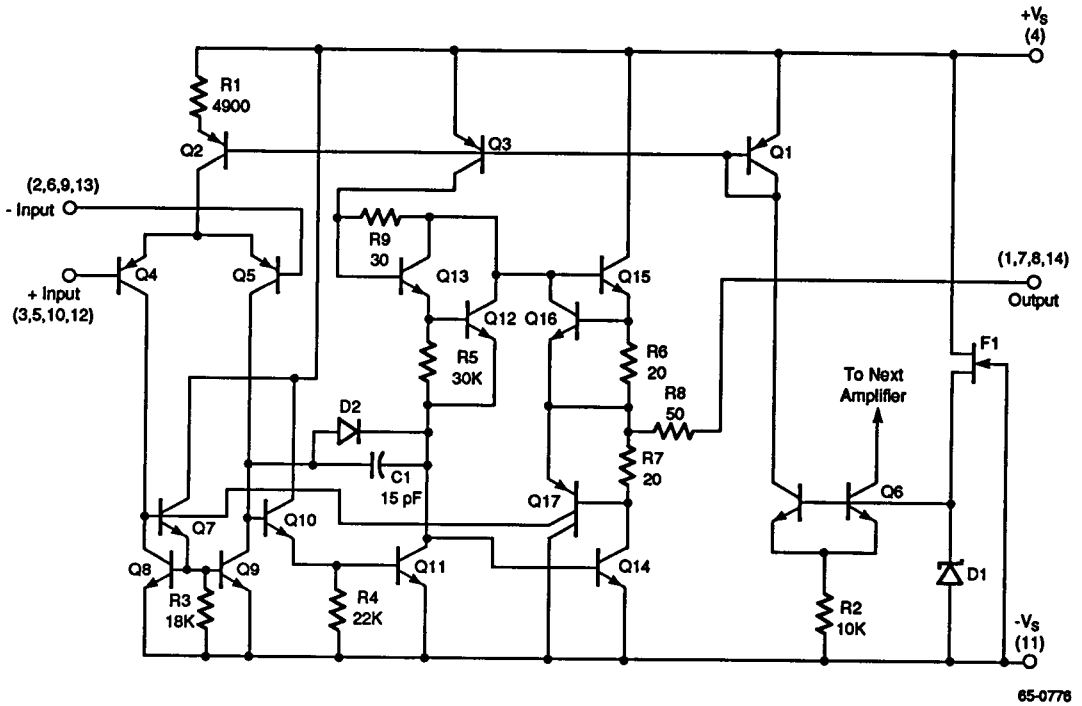

Linear