

**CD4071BM/CD4071BC**  
**Quad 2-Input OR Buffered B Series Gate**  
**CD4081BM/CD4081BC**  
**Quad 2-Input AND Buffered B Series Gate**

**General Description**

These quad gates are monolithic complementary MOS (CMOS) integrated circuits constructed with N- and P-channel enhancement mode transistors. They have equal source and sink current capabilities and conform to standard B series output drive. The devices also have buffered outputs which improve transfer characteristics by providing very high gain.

All inputs protected against static discharge with diodes to  $V_{DD}$  and  $V_{SS}$ .

**Features**

- Low power TTL compatibility
- 5V–10V–15V parametric ratings
- Symmetrical output characteristics
- Maximum input leakage 1  $\mu$ A at 15V over full temperature range

Fan out of 2 driving 74L  
 or 1 driving 74LS

**Connection Diagrams**

**CD4071B Dual-In-Line Package**

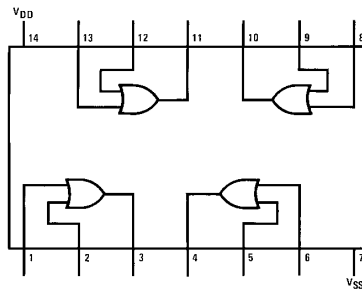

**Top View**

TL/F/5977-3

**CD4081B Dual-In-Line Package**

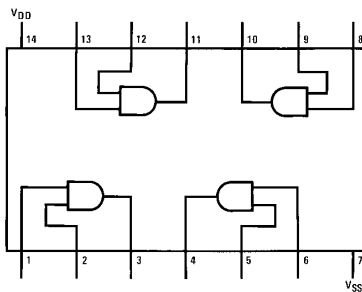

**Top View**

TL/F/5977-6

**Order Number CD4071B or CD4081B**

**CD4071BM/CD4071BC Quad 2-Input OR Buffered B Series Gate**  
**CD4081BM/CD4081BC Quad 2-Input AND Buffered B Series Gate**

## Absolute Maximum Ratings (Notes 1 & 2)

If Military/Aerospace specified devices are required, please contact the National Semiconductor Sales Office/Distributors for availability and specifications.

Voltage at Any Pin	-0.5V to $V_{DD}$ + 0.5V
Power Dissipation ( $P_D$ )	
Dual-In-Line	700 mW
Small Outline	500 mW
$V_{DD}$ Range	-0.5 $V_{DC}$ to +18 $V_{DC}$
Storage Temperature ( $T_S$ )	-65°C to +150°C

Lead Temperature ( $T_L$ )  
(Soldering, 10 seconds) 260°C

## Operating Conditions

Operating Range ( $V_{DD}$ )	3 $V_{DC}$ to 15 $V_{DC}$
Operating Temperature Range ( $T_A$ )	
CD4071BM, CD4081BM	-55°C to +125°C
CD4071BC, CD4081BC	-40°C to +85°C

## DC Electrical Characteristics CD4071BM/CD4081BM (Note 2)

Symbol	Parameter	Conditions	-55°C		+25°C			+125°C		Units
			Min	Max	Min	Typ	Max	Min	Max	
$I_{DD}$	Quiescent Device Current	$V_{DD} = 5V$		0.25		0.004	0.25		7.5	$\mu A$
		$V_{DD} = 10V$		0.50		0.005	0.50		15	$\mu A$
		$V_{DD} = 15V$		1.0		0.006	1.0		30	$\mu A$
$V_{OL}$	Low Level Output Voltage	$V_{DD} = 5V$	} $ I_O  < 1 \mu A$	0.05		0	0.05		0.05	V
		$V_{DD} = 10V$		0.05		0	0.05		0.05	V
		$V_{DD} = 15V$		0.05		0	0.05		0.05	V
$V_{OH}$	High Level Output Voltage	$V_{DD} = 5V$	} $ I_O  < 1 \mu A$	4.95		4.95	5		4.95	V
		$V_{DD} = 10V$		9.95		9.95	10		9.95	V
		$V_{DD} = 15V$		14.95		14.95	15		14.95	V
$V_{IL}$	Low Level Input Voltage	$V_{DD} = 5V, V_O = 0.5V$		1.5		2	1.5		1.5	V
		$V_{DD} = 10V, V_O = 1.0V$		3.0		4	3.0		3.0	V
		$V_{DD} = 15V, V_O = 1.5V$		4.0		6	4.0		4.0	V
$V_{IH}$	High Level Input Voltage	$V_{DD} = 5V, V_O = 4.5V$		3.5		3.5	3		3.5	V
		$V_{DD} = 10V, V_O = 9.0V$		7.0		7.0	6		7.0	V
		$V_{DD} = 15V, V_O = 13.5V$		11.0		11.0	9		11.0	V
$I_{OL}$	Low Level Output Current (Note 3)	$V_{DD} = 5V, V_O = 0.4V$		0.64		0.51	0.88		0.36	mA
		$V_{DD} = 10V, V_O = 0.5V$		1.6		1.3	2.25		0.9	mA
		$V_{DD} = 15V, V_O = 1.5V$		4.2		3.4	8.8		2.4	mA
$I_{OH}$	High Level Output Current (Note 3)	$V_{DD} = 5V, V_O = 4.6V$		-0.64		-0.51	-0.88		-0.36	mA
		$V_{DD} = 10V, V_O = 9.5V$		-1.6		-1.3	-2.25		-0.9	mA
		$V_{DD} = 15V, V_O = 13.5V$		-4.2		-3.4	-8.8		-2.4	mA
$I_{IN}$	Input Current	$V_{DD} = 15V, V_{IN} = 0V$		-0.10		-10 <sup>-5</sup>	-0.10		-1.0	$\mu A$
		$V_{DD} = 15V, V_{IN} = 15V$		0.10		10 <sup>-5</sup>	0.10		1.0	$\mu A$

**Note 1:** "Absolute Maximum Ratings" are those values beyond which the safety of the device cannot be guaranteed. Except for "Operating Temperature Range" they are not meant to imply that the devices should be operated at these limits. The table of "Electrical Characteristics" provides conditions for actual device operation.

**Note 2:** All voltages measured with respect to  $V_{SS}$  unless otherwise specified.

**Note 3:**  $I_{OH}$  and  $I_{OL}$  are tested one output at a time.

## DC Electrical Characteristics CD4071BC/CD4081BC (Note 2)

Symbol	Parameter	Conditions	-40°C		+25°C			+85°C		Units
			Min	Max	Min	Typ	Max	Min	Max	
I <sub>DD</sub>	Quiescent Device Current	V <sub>DD</sub> = 5V		1		0.004	1		7.5	μA
		V <sub>DD</sub> = 10V		2		0.005	2		15	μA
		V <sub>DD</sub> = 15V		4		0.006	4		30	μA
V <sub>OL</sub>	Low Level Output Voltage	V <sub>DD</sub> = 5V	I <sub>O</sub>   < 1 μA	0.05		0	0.05		0.05	V
		V <sub>DD</sub> = 10V		0.05		0	0.05		0.05	V
		V <sub>DD</sub> = 15V		0.05		0	0.05		0.05	V
V <sub>OH</sub>	High Level Output Voltage	V <sub>DD</sub> = 5V	I <sub>O</sub>   < 1 μA	4.95		4.95	5		4.95	V
		V <sub>DD</sub> = 10V		9.95		9.95	10		9.95	V
		V <sub>DD</sub> = 15V		14.95		14.95	15		14.95	V
V <sub>IL</sub>	Low Level Input Voltage	V <sub>DD</sub> = 5V, V <sub>O</sub> = 0.5V		1.5		2	1.5		1.5	V
		V <sub>DD</sub> = 10V, V <sub>O</sub> = 1.0V		3.0		4	3.0		3.0	V
		V <sub>DD</sub> = 15V, V <sub>O</sub> = 1.5V		4.0		6	4.0		4.0	V
V <sub>IH</sub>	High Level Input Voltage	V <sub>DD</sub> = 5V, V <sub>O</sub> = 4.5V		3.5		3.5	3		3.5	V
		V <sub>DD</sub> = 10V, V <sub>O</sub> = 9.0V		7.0		7.0	6		7.0	V
		V <sub>DD</sub> = 15V, V <sub>O</sub> = 13.5V		11.0		11.0	9		11.0	V
I <sub>OL</sub>	Low Level Output Current (Note 3)	V <sub>DD</sub> = 5V, V <sub>O</sub> = 0.4V		0.52		0.44	0.88		0.36	mA
		V <sub>DD</sub> = 10V, V <sub>O</sub> = 0.5V		1.3		1.1	2.25		0.9	mA
		V <sub>DD</sub> = 15V, V <sub>O</sub> = 1.5V		3.6		3.0	8.8		2.4	mA
I <sub>OH</sub>	High Level Output Current (Note 3)	V <sub>DD</sub> = 5V, V <sub>O</sub> = 4.6V		-0.52		-0.44	-0.88		-0.36	mA
		V <sub>DD</sub> = 10V, V <sub>O</sub> = 9.5V		-1.3		-1.1	-2.25		-0.9	mA
		V <sub>DD</sub> = 15V, V <sub>O</sub> = 13.5V		-3.6		-3.0	-8.8		-2.4	mA
I <sub>IN</sub>	Input Current	V <sub>DD</sub> = 15V, V <sub>IN</sub> = 0V		-0.30		-10 <sup>-5</sup>	-0.30		-1.0	μA
		V <sub>DD</sub> = 15V, V <sub>IN</sub> = 15V		0.30		10 <sup>-5</sup>	0.30		1.0	μA

## AC Electrical Characteristics\* CD4071BC/CD4071BM

T<sub>A</sub> = 25°C, Input t<sub>r</sub>, t<sub>f</sub> = 20 ns, C<sub>L</sub> = 50 pF, R<sub>L</sub> = 200 kΩ, Typical temperature coefficient is 0.3%/°C

Symbol	Parameter	Conditions	Typ	Max	Units
t <sub>PHL</sub>	Propagation Delay Time, High-to-Low Level	V <sub>DD</sub> = 5V	100	250	ns
		V <sub>DD</sub> = 10V	40	100	ns
		V <sub>DD</sub> = 15V	30	70	ns
t <sub>PLH</sub>	Propagation Delay Time, Low-to-High Level	V <sub>DD</sub> = 5V	90	250	ns
		V <sub>DD</sub> = 10V	40	100	ns
		V <sub>DD</sub> = 15V	30	70	ns
t <sub>THL</sub> , t <sub>TLH</sub>	Transition Time	V <sub>DD</sub> = 5V	90	200	ns
		V <sub>DD</sub> = 10V	50	100	ns
		V <sub>DD</sub> = 15V	40	80	ns
C <sub>IN</sub>	Average Input Capacitance	Any Input	5	7.5	pF
C <sub>PD</sub>	Power Dissipation Capacity	Any Gate	18		pF

\*AC Parameters are guaranteed by DC correlated testing.

**Note 1:** "Absolute Maximum Ratings" are those values beyond which the safety of the device cannot be guaranteed. Except for "Operating Temperature Range" they are not meant to imply that the devices should be operated at these limits. The table of "Electrical Characteristics" provides conditions for actual device operation.

**Note 2:** All voltages measured with respect to V<sub>SS</sub> unless otherwise specified.

**Note 3:** I<sub>OH</sub> and I<sub>OL</sub> are tested one output at a time.

## AC Electrical Characteristics\* CD4081BC/CD4081BM

$T_A = 25^\circ\text{C}$ , Input  $t_r$ ;  $t_f = 20\text{ ns}$ ,  $C_L = 50\text{ pF}$ ,  $R_L = 200\text{ k}\Omega$ , Typical temperature coefficient is  $0.3\%/^\circ\text{C}$

Symbol	Parameter	Conditions	Typ	Max	Units
$t_{PHL}$	Propagation Delay Time, High-to-Low Level	$V_{DD} = 5\text{V}$	100	250	ns
		$V_{DD} = 10\text{V}$	40	100	ns
		$V_{DD} = 15\text{V}$	30	70	ns
$t_{PLH}$	Propagation Delay Time, Low-to-High Level	$V_{DD} = 5\text{V}$	120	250	ns
		$V_{DD} = 10\text{V}$	50	100	ns
		$V_{DD} = 15\text{V}$	35	70	ns
$t_{THL}, t_{TLH}$	Transition Time	$V_{DD} = 5\text{V}$	90	200	ns
		$V_{DD} = 10\text{V}$	50	100	ns
		$V_{DD} = 15\text{V}$	40	80	ns
$C_{IN}$	Average Input Capacitance	Any Input	5	7.5	pF
$C_{PD}$	Power Dissipation Capacity	Any Gate	18		pF

\*AC Parameters are guaranteed by DC correlated testing.

## Typical Performance Characteristics

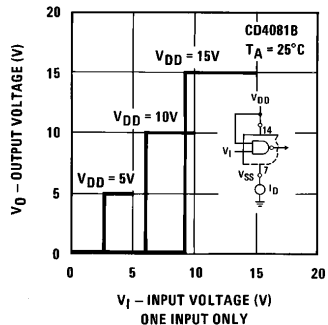

TL/F/5977-7

FIGURE 1. Typical Transfer Characteristics

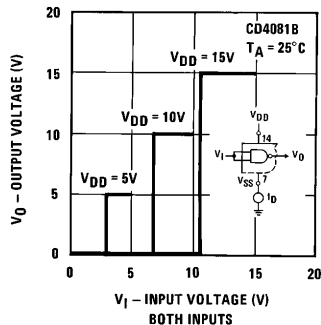

TL/F/5977-8

FIGURE 2. Typical Transfer Characteristics

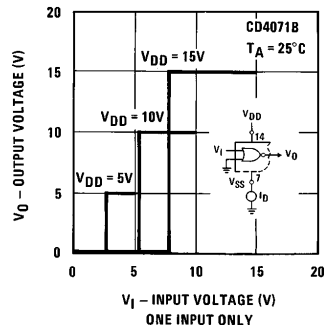

TL/F/5977-9

FIGURE 3. Typical Transfer Characteristics

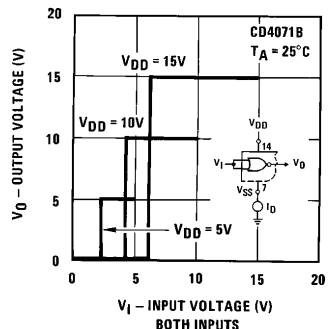

TL/F/5977-10

FIGURE 4. Typical Transfer Characteristics

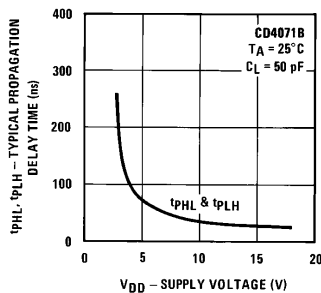

TL/F/5977-11

FIGURE 5

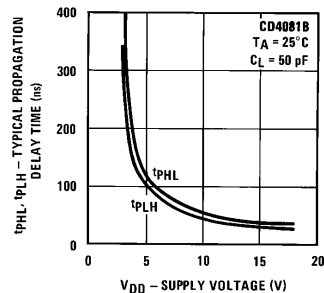

TL/F/5977-12

FIGURE 6

## Typical Performance Characteristics (Continued)

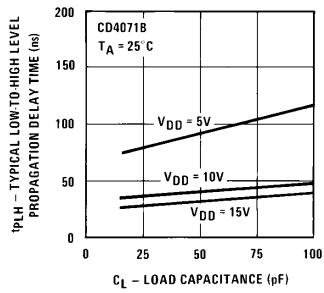

FIGURE 7

TL/F/5977-13

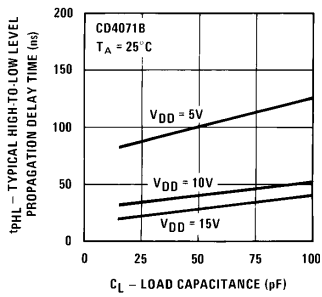

FIGURE 8

TL/F/5977-14

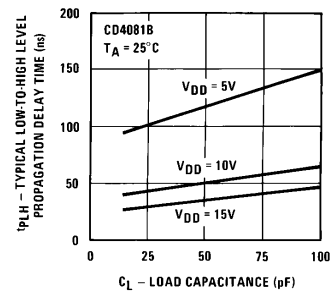

FIGURE 9

TL/F/5977-15

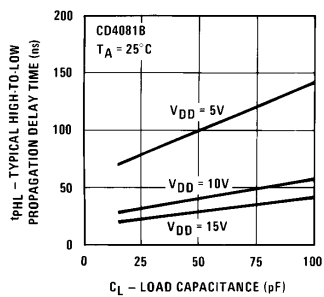

FIGURE 10

TL/F/5977-16

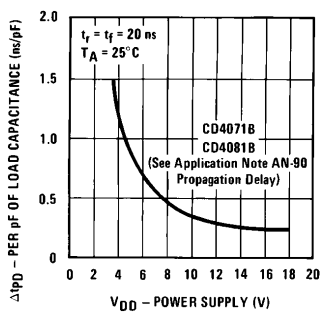

FIGURE 11

TL/F/5977-17

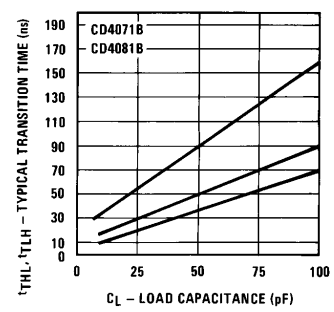

FIGURE 12

TL/F/5977-18

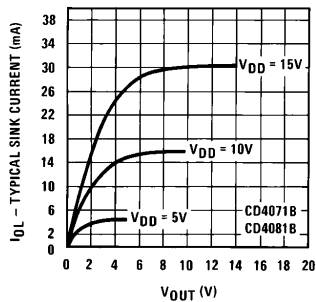

FIGURE 13

TL/F/5977-19

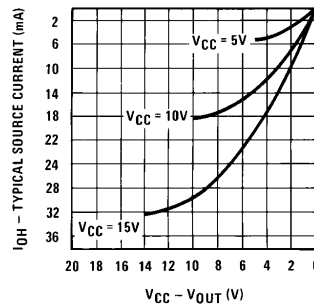
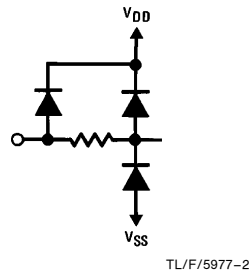
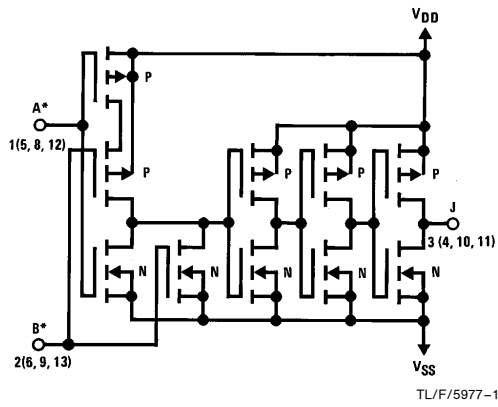

FIGURE 14

TL/F/5977-20

## Schematic Diagrams

CD4071B



1/4 of device shown  
 $J = A + B$   
 Logical "1" = High  
 Logical "0" = Low  
 \*All inputs protected by standard CMOS protection circuit.

CD4081B

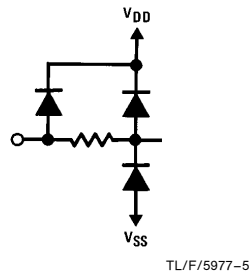
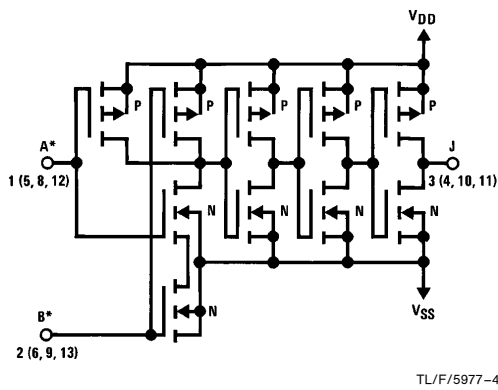

1/4 of device shown  
 $J = A \cdot B$   
 Logical "1" = High  
 Logical "0" = Low  
 \*All inputs protected by standard CMOS protection circuit.

**Physical Dimensions** inches (millimeters)

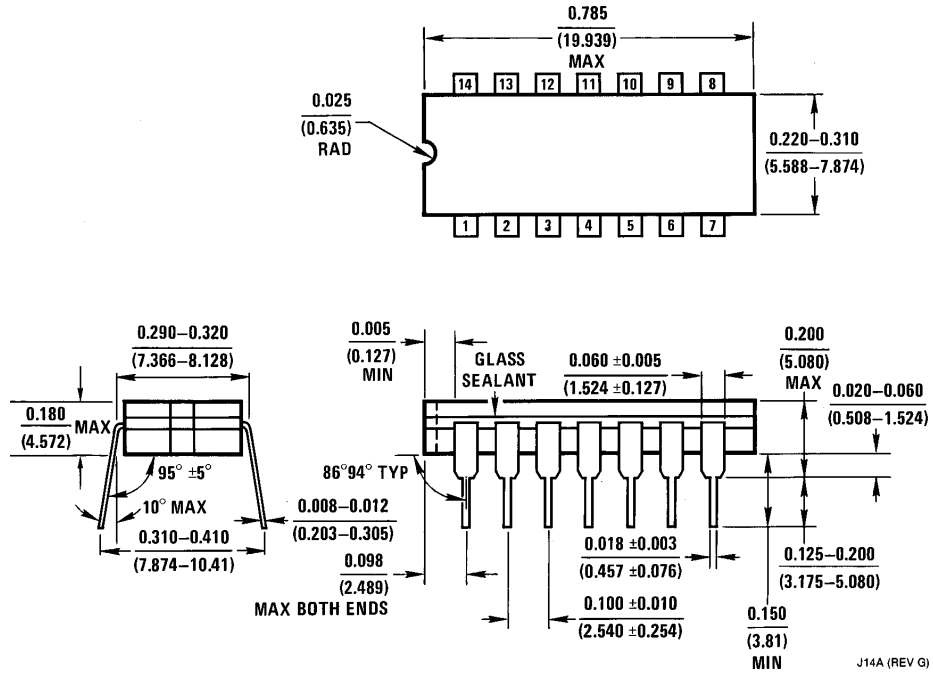

**Ceramic Dual-In-Line Package (J)**  
**Order Number CD4071BMJ, CD4071BCJ**  
**CD4081BMJ or CD4081BCJ**  
**NS Package Number J14A**

**CD4071BM/CD4071BC Quad 2-Input OR Buffered B Series Gate  
 CD4081BM/CD4081BC Quad 2-Input AND Buffered B Series Gate**

**Physical Dimensions** inches (millimeters) (Continued)

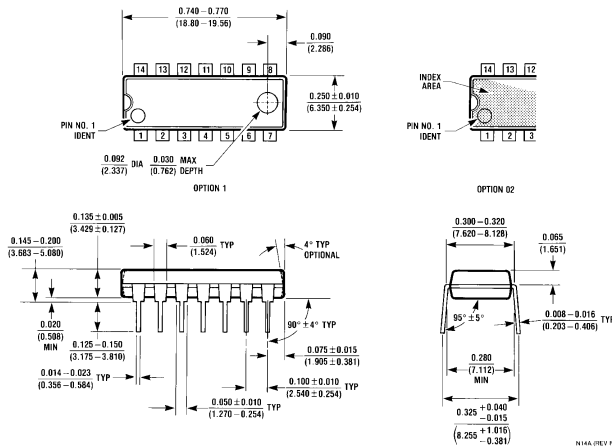

**Molded Dual-In-Line Package (N)**  
**Order Number CD4071BMN, CD4071BCN**  
**CD4081BMN or CD4081BCN**  
**NS Package Number N14A**

**LIFE SUPPORT POLICY**

NATIONAL'S PRODUCTS ARE NOT AUTHORIZED FOR USE AS CRITICAL COMPONENTS IN LIFE SUPPORT DEVICES OR SYSTEMS WITHOUT THE EXPRESS WRITTEN APPROVAL OF THE PRESIDENT OF NATIONAL SEMICONDUCTOR CORPORATION. As used herein:

1. Life support devices or systems are devices or systems which, (a) are intended for surgical implant into the body, or (b) support or sustain life, and whose failure to perform, when properly used in accordance with instructions for use provided in the labeling, can be reasonably expected to result in a significant injury to the user.
2. A critical component is any component of a life support device or system whose failure to perform can be reasonably expected to cause the failure of the life support device or system, or to affect its safety or effectiveness.



**National Semiconductor Corporation**  
 1111 West Bardin Road  
 Arlington, TX 76017  
 Tel: 1(800) 272-9959  
 Fax: 1(800) 737-7018

**National Semiconductor Europe**  
 Fax: (+49) 0-180-530 85 86  
 Email: cnjwge@tevm2.nsc.com  
 Deutsch Tel: (+49) 0-180-530 85 85  
 English Tel: (+49) 0-180-532 78 32  
 Français Tel: (+49) 0-180-532 93 58  
 Italiano Tel: (+49) 0-180-534 16 80

**National Semiconductor Hong Kong Ltd.**  
 19th Floor, Straight Block,  
 Ocean Centre, 5 Canton Rd.  
 Tsimshatsui, Kowloon  
 Hong Kong  
 Tel: (852) 2737-1600  
 Fax: (852) 2736-9960

**National Semiconductor Japan Ltd.**  
 Tel: 81-043-299-2309  
 Fax: 81-043-299-2408

National does not assume any responsibility for use of any circuitry described, no circuit patent licenses are implied and National reserves the right at any time without notice to change said circuitry and specifications.