

54ABT374

Octal D-Type Flip-Flop with TRI-STATE® Outputs

General Description

The 'ABT374 is an octal D-type flip-flop featuring separate D-type inputs for each flip-flop and TRI-STATE outputs for bus-oriented applications. A buffered Clock (CP) and Output Enable (\overline{OE}) are common to all flip-flops.

Features

- Edge-triggered D-type inputs
- Buffered positive edge-triggered clock
- TRI-STATE outputs for bus-oriented applications
- Output sink capability of 48 mA, source capability of 24 mA

- Guaranteed multiple output switching specifications
- Output switching specified for both 50 pF and 250 pF loads
- Guaranteed simultaneous switching, noise level and dynamic threshold performance
- Guaranteed latchup protection
- High impedance glitch free bus loading during entire power up and power down cycle
- Non-destructive hot insertion capability
- Standard Microcircuit Drawing (SMD) 5962-9314901

Ordering Code

Military	Package Number	Package Description
54ABT374J/883	J20A	20-Lead Ceramic Dual-In-Line
54ABT374W/883	W20A	20-Lead Cerpack
54ABT374E/883	E20A	20-Lead Ceramic Leadless Chip Carrier, Type C

Connection Diagrams

Pin Assignment for DIP and Flatpak

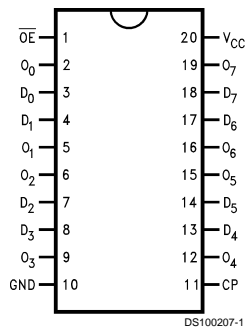

Pin Assignment for LCC

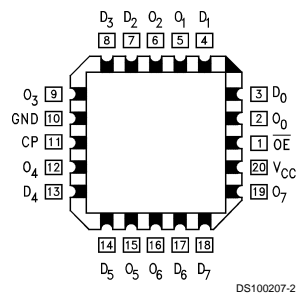

TRI-STATE® is a registered trademark of National Semiconductor Corporation.

Pin Descriptions

Pin Names	Description
D ₀ –D ₇	Data Inputs
CP	Clock Pulse Input (Active Rising Edge)
\overline{OE}	TRI-STATE Output Enable Input (Active LOW)
O ₀ –O ₇	TRI-STATE Outputs

Functional Description

The 'ABT374 consists of eight edge-triggered flip-flops with individual D-type inputs and TRI-STATE true outputs. The buffered clock and buffered Output Enable are common to all flip-flops. The eight flip-flops will store the state of their individual D inputs that meet the setup and hold time requirements on the LOW-to-HIGH Clock (CP) transition. With the Output Enable (\overline{OE}) LOW, the contents of the eight flip-flops are available at the outputs. When \overline{OE} is HIGH, the outputs are in a high impedance state. Operation of the \overline{OE} input does not affect the state of the flip-flops.

Function Table

Inputs			Internal	Outputs	Function
\overline{OE}	CP	D	Q	O	
H	H	L	NC	Z	Hold
H	H	H	NC	Z	Hold
H	↗	L	L	Z	Load
H	↗	H	H	Z	Load
L	↗	L	L	L	Data Available
L	↗	H	H	H	Data Available
L	H	L	NC	NC	No Change in Data
L	H	H	NC	NC	No Change in Data

H = HIGH Voltage Level
 L = LOW Voltage Level
 X = Immaterial
 Z = High Impedance
 ↗ = LOW-to-HIGH Transition
 NC = No Change

Logic Diagram

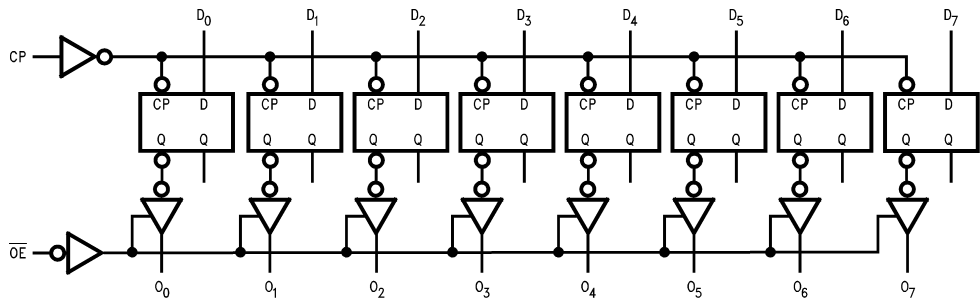

Please note that this diagram is provided only for the understanding of logic operations and should not be used to estimate propagation delays.

Absolute Maximum Ratings (Note 1)

If Military/Aerospace specified devices are required, please contact the National Semiconductor Sales Office/Distributors for availability and specifications.

Storage Temperature	-65°C to +150°C
Ambient Temperature under Bias	-55°C to +125°C
Junction Temperature under Bias	
Ceramic	-55°C to +175°C
V _{CC} Pin Potential to Ground Pin	-0.5V to +7.0V
Input Voltage (Note 2)	-0.5V to +7.0V
Input Current (Note 2)	-30 mA to +5.0 mA
Voltage Applied to Any Output in the Disabled or Power-Off State	-0.5V to 5.5V
in the HIGH State	-0.5V to V _{CC}
Current Applied to Output in LOW State (Max)	twice the rated I _{OL} (mA)

DC Latchup Source Current:

\overline{OE} Pin	-150 mA
(Across Comm Operating Range)	
Other Pins	-500 mA
Over Voltage Latchup (I/O)	10V

Recommended Operating Conditions

Free Air Ambient Temperature	
Military	-55°C to +125°C
Supply Voltage	
Military	+4.5V to +5.5V
Minimum Input Edge Rate	($\Delta V/\Delta t$)
Data Input	50 mV/ns
Enable Input	20 mV/ns
Clock Input	100mV/ns

Note 1: Absolute maximum ratings are values beyond which the device may be damaged or have its useful life impaired. Functional operation under these conditions is not implied.

Note 2: Either voltage limit or current limit is sufficient to protect inputs.

DC Electrical Characteristics

Symbol	Parameter	ABT374			Units	V _{CC}	Conditions
		Min	Typ	Max			
V _{IH}	Input HIGH Voltage	2.0			V		Recognized HIGH Signal
V _{IL}	Input LOW Voltage			0.8	V		Recognized LOW Signal
V _{CD}	Input Clamp Diode Voltage			-1.2	V	Min	I _{IN} = -18 mA
V _{OH}	Output HIGH Voltage	54ABT	2.5		V	Min	I _{OH} = -3 mA
		54ABT	2.0		V	Min	I _{OH} = -24 mA
V _{OL}	Output LOW Voltage	54ABT		0.55	V	Min	I _{OL} = 48 mA
I _{IH}	Input HIGH Current		5		μA	Max	V _{IN} = 2.7V (Note 4)
			5		μA	Max	V _{IN} = V _{CC}
I _{BVI}	Input HIGH Current Breakdown Test		7		μA	Max	V _{IN} = 7.0V
I _{IL}	Input LOW Current		-5		μA	Max	V _{IN} = 0.5V (Note 4)
			-5		μA	Max	V _{IN} = 0.0V
V _{ID}	Input Leakage Test	4.75			V	0.0	I _{ID} = 1.9 μA All Other Pins Grounded
I _{OZH}	Output Leakage Current		50		μA	0 - 5.5V	V _{OUT} = 2.7V; \overline{OE} = 2.0V
I _{OZL}	Output Leakage Current		-50		μA	0 - 5.5V	V _{OUT} = 0.5V; \overline{OE} = 2.0V
I _{OS}	Output Short-Circuit Current	-100	-275		mA	Max	V _{OUT} = 0.0V
I _{CEX}	Output High Leakage Current		50		μA	Max	V _{OUT} = V _{CC}
I _{ZZ}	Bus Drainage Test		100		μA	0.0	V _{OUT} = 5.5V; All Others V _{CC} or GND
I _{CCH}	Power Supply Current		50		μA	Max	All Outputs HIGH
I _{CCL}	Power Supply Current		30		mA	Max	All Outputs LOW
I _{CCZ}	Power Supply Current		50		μA	Max	\overline{OE} = V _{CC} ; All Others at V _{CC} or GND
I _{CCCT}	Additional I _{CC} /Input	Outputs Enabled	2.5		mA		V _I = V _{CC} - 2.1V
		Outputs TRI-STATE	2.5		mA	Max	Enable Input V _I = V _{CC} - 2.1V
		Outputs TRI-STATE	2.5		mA		Data Input V _I = V _{CC} - 2.1V All Others at V _{CC} or GND

DC Electrical Characteristics (Continued)

Symbol	Parameter	ABT374			Units	V _{CC}	Conditions
		Min	Typ	Max			
I _{CCD}	Dynamic I _{CC} No Load (Note 4)		0.30		mA/ MHz	Max	Outputs Open OE = GND, (Note 3) One Bit Toggling, 50% Duty Cycle

Note 3: For 8-bit toggling, I_{CCD} < 0.8 mA/MHz.

Note 4: Guaranteed, but not tested.

AC Electrical Characteristics

Symbol	Parameter	54ABT		Units
		T _A = -55°C to +125°C V _{CC} = 4.5V to 5.5V C _L = 50 pF		
		Min	Max	
f _{max}	Max Clock Frequency	150		MHz
t _{PLH}	Propagation Delay	1.4	6.6	ns
t _{PHL}	CP to O _n	2.0	7.6	
t _{PZH}	Output Enable Time	0.8	5.7	ns
t _{PZL}		1.5	7.2	
t _{PHZ}	Output Disable Time	1.3	7.2	ns
t _{PLZ}		1.0	7.0	

AC Operating Requirements

Symbol	Parameter	54ABT		Units
		T _A = -55°C to +125°C V _{CC} = 4.5V to 5.5V C _L = 50 pF		
		Min	Max	
t _s (H)	Setup Time, HIGH	2.5		ns
t _s (L)	or LOW D _n to CP	2.5		
t _h (H)	Hold Time, HIGH	2.5		ns
t _h (L)	or LOW D _n to CP	2.5		
t _w (H)	Pulse Width, CP	3.3		ns
t _w (L)	HIGH or LOW	3.3		

Capacitance

Symbol	Parameter	Typ	Units	Conditions (T _A = 25°C)
C _{IN}	Input Capacitance	5.0	pF	V _{CC} = 0V
C _{OUT} (Note 5)	Output Capacitance	9.0	pF	V _{CC} = 5.0V

Note 5: C_{OUT} is measured at frequency f = 1 MHz, per MIL-STD-883B, Method 3012.

Capacitance (Continued)

**t_{PLH} vs Temperature (T_A) $C_L = 50$ pF,
1 Output Switching Clock to Output**

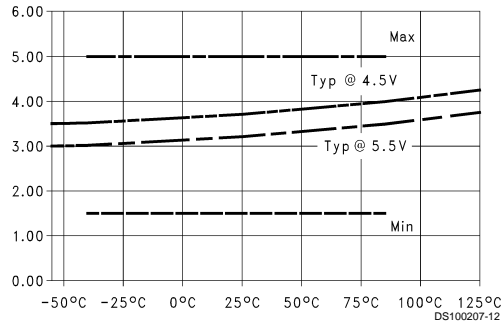

**t_{PHL} vs Temperature (T_A) $C_L = 50$ pF,
1 Output Switching Clock to Output**

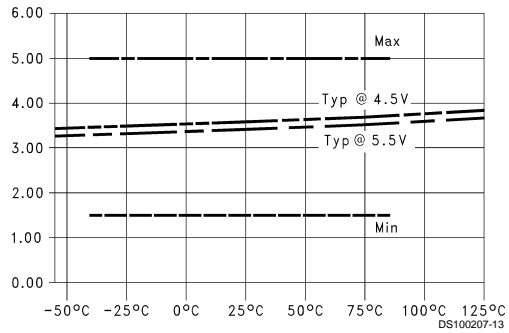

**t_{PZH} vs Temperature (T_A) $C_L = 50$ pF,
1 Output Switching OE to Output**

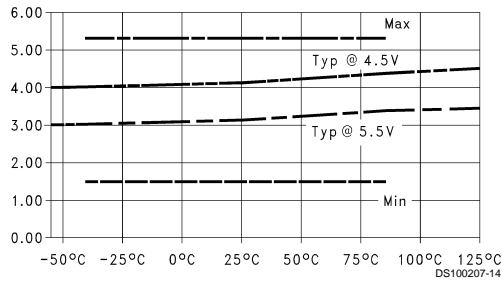

**t_{PZL} vs Temperature (T_A) $C_L = 50$ pF,
1 Output Switching OE to Output**

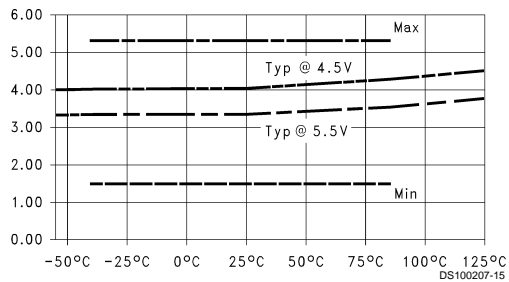

**t_{PHZ} vs Temperature (T_A) $C_L = 50$ pF,
1 Output Switching OE to Output**

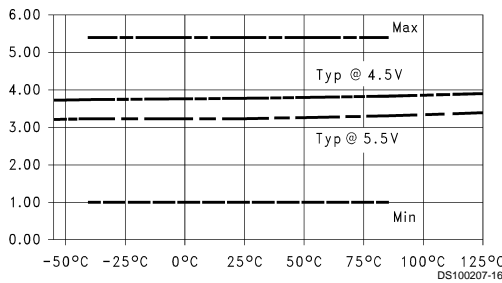

**t_{PLZ} vs Temperature (T_A) $C_L = 50$ pF,
1 Output Switching OE to Output**

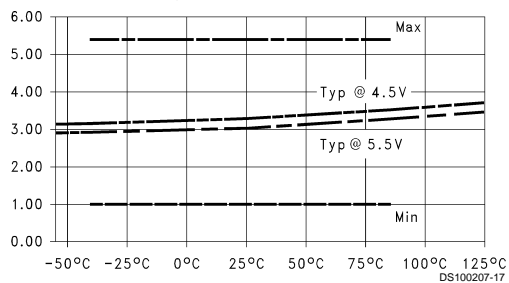

Dashed lines represent design characteristics; for specified guarantees, refer to AC Characteristics Tables.

Capacitance (Continued)

**t_{SET} LOW vs Temperature (T_A) $C_L = 50$ pF,
1 Output Switching Data to Clock**

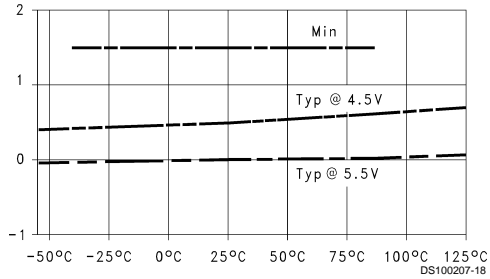

**t_{SET} HIGH vs Temperature (T_A) $C_L = 50$ pF,
1 Output Switching Data to Clock**

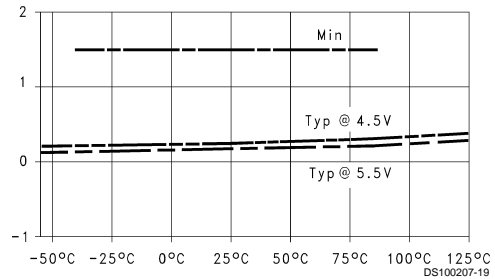

**t_{HOLD} HIGH vs Temperature (T_A) $C_L = 50$ pF,
1 Output Switching Data to Clock**

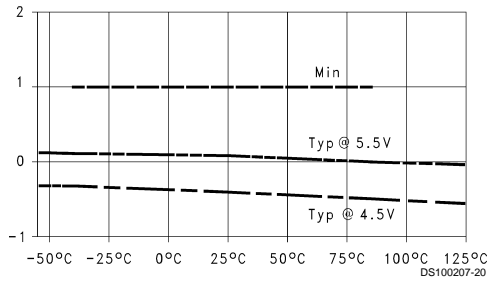

**t_{HOLD} LOW vs Temperature (T_A) $C_L = 50$ pF,
1 Output Switching Data to Clock**

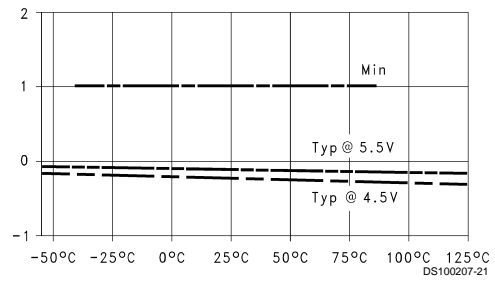

**t_{PLH} vs Temperature (T_A) $C_L = 50$ pF,
8 Outputs Switching Clock to Output**

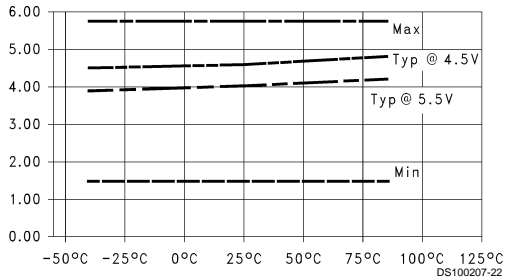

**t_{PHL} vs Temperature (T_A) $C_L = 50$ pF,
8 Outputs Switching Clock to Output**

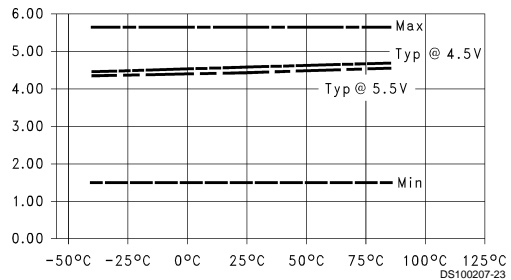

Dashed lines represent design characteristics; for specified guarantees, refer to AC Characteristics Tables.

Capacitance (Continued)

**t_{PZH} vs Temperature (T_A) $C_L = 50$ pF,
8 Outputs Switching OE to Output**

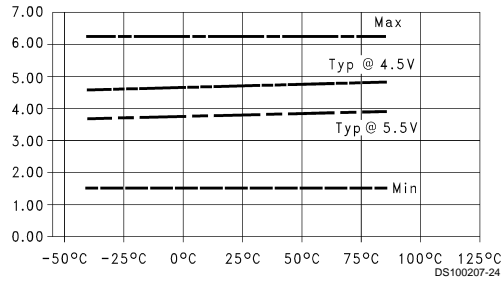

**t_{PZL} vs Temperature (T_A) $C_L = 50$ pF,
8 Outputs Switching OE to Output**

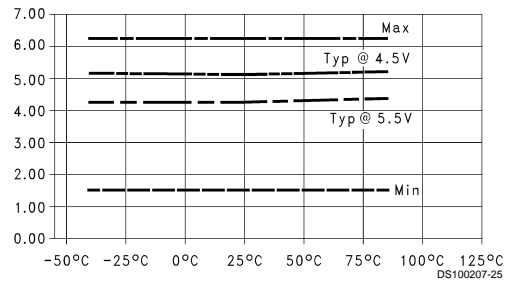

**t_{PHZ} vs Temperature (T_A) $C_L = 50$ pF,
8 Outputs Switching OE to Output**

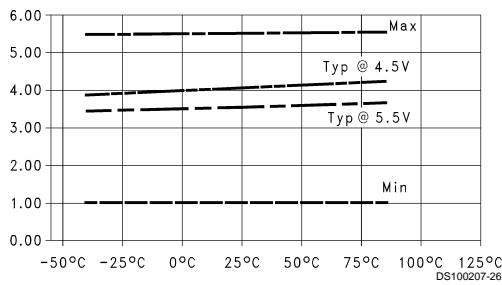

**t_{PLZ} vs Temperature (T_A) $C_L = 50$ pF,
8 Outputs Switching OE to Output**

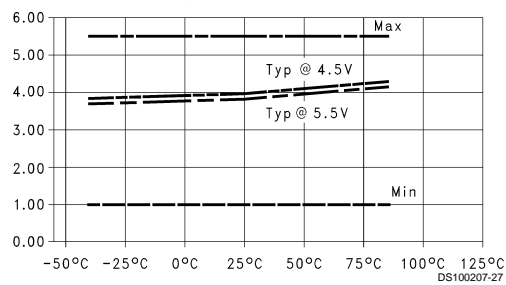

**t_{PLH} vs Load Capacitance $T_A = 25^\circ\text{C}$,
1 Output Switching Clock to Output**

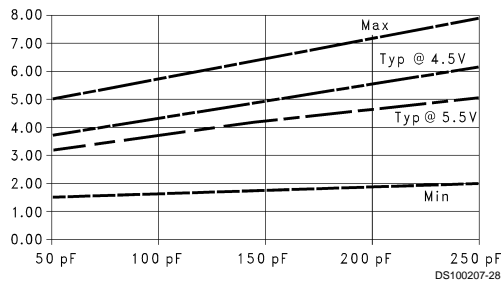

**t_{PHL} vs Load Capacitance $T_A = 25^\circ\text{C}$,
1 Output Switching Clock to Output**

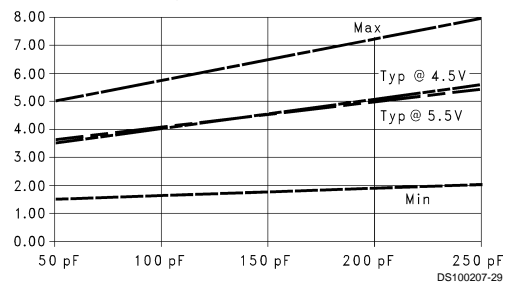

Dashed lines represent design characteristics; for specified guarantees, refer to AC Characteristics Tables.

Capacitance (Continued)

**t_{PLH} vs Load Capacitance $T_A = 25^\circ\text{C}$,
8 Outputs Switching Clock to Output**

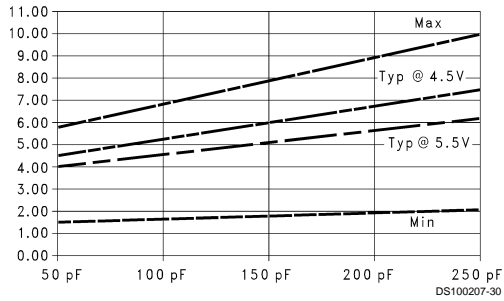

**t_{PHL} vs Load Capacitance $T_A = 25^\circ\text{C}$,
8 Outputs Switching Clock to Output**

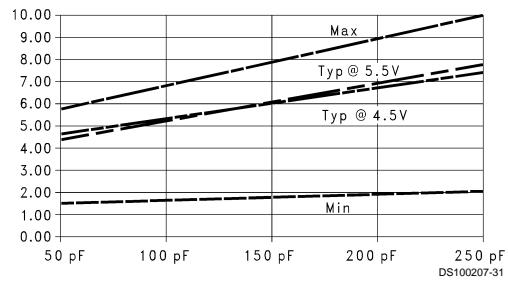

**t_{PZH} vs Load Capacitance $T_A = 25^\circ\text{C}$,
8 Outputs Switching OE to Output**

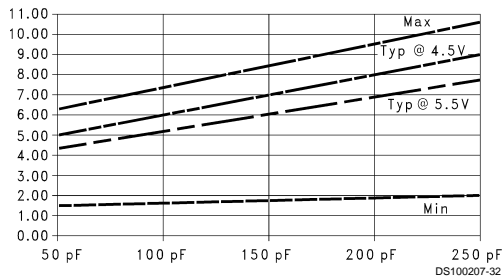

**t_{PZL} vs Load Capacitance $T_A = 25^\circ\text{C}$,
8 Outputs Switching OE to Output**

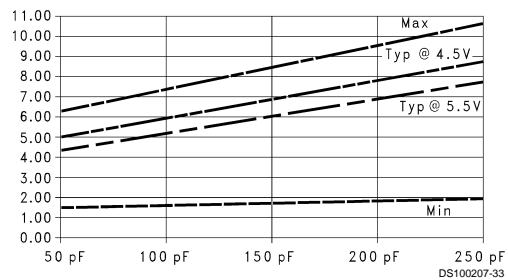

**t_{PLH} and t_{PHL} vs Number Outputs Switching
 $C_L = 50\text{ pF}$, $T_A = 25^\circ\text{C}$, $V_{CC} = 5.0\text{V}$,
Outputs in Phase Clock to Output**

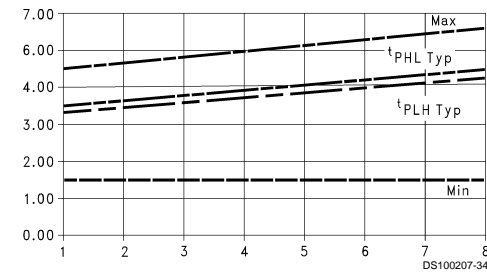

**Typical I_{CC} vs Output Switching Frequency
 $C_L = 0\text{ pF}$, $V_{CC} = V_{IH} = 5.5\text{V}$, 1 Output
Switching at 50% Duty Cycle Clock to Output**

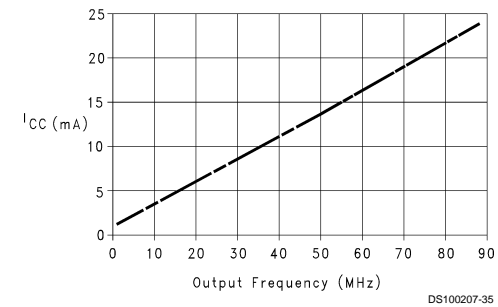

Dashed lines represent design characteristics; for specified guarantees, refer to AC Characteristics Tables.

AC Loading

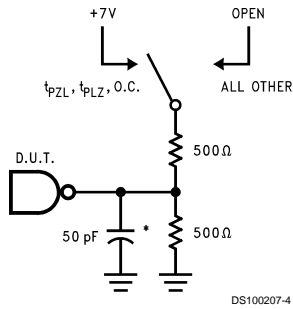

*Includes jig and probe capacitance

FIGURE 1. Standard AC Test Load

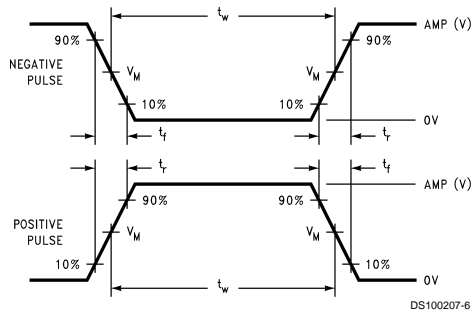

FIGURE 2. $V_M = 1.5V$

Input Pulse Requirements

Amplitude	Rep. Rate	t_w	t_r	t_f
3.0V	1 MHz	500 ns	2.5 ns	2.5 ns

FIGURE 3. Test Input Signal Requirements

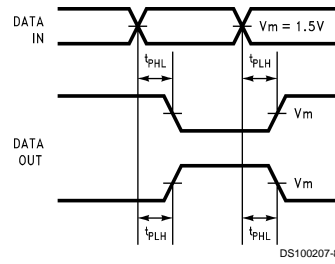

FIGURE 4. Propagation Delay Waveforms for Inverting and Non-Inverting Functions

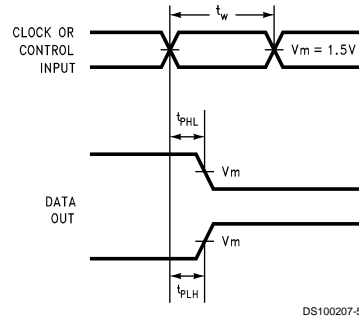

FIGURE 5. Propagation Delay, Pulse Width Waveforms

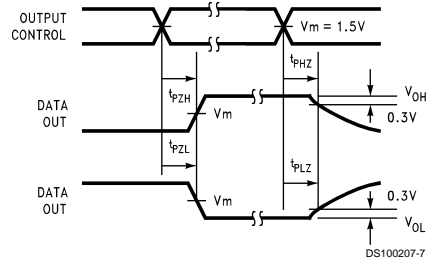

FIGURE 6. TRI-STATE Output HIGH and LOW Enable and Disable Times

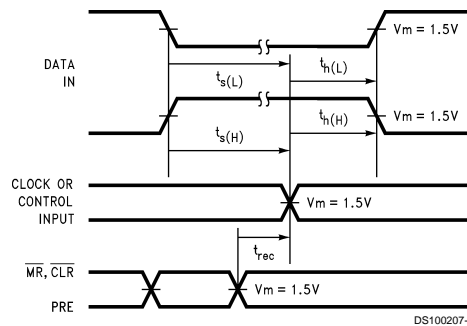
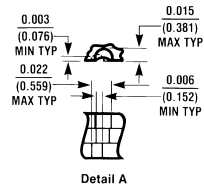
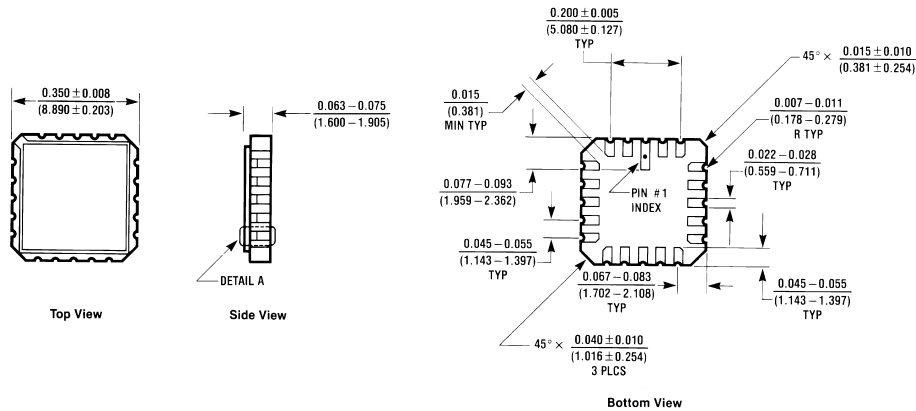

FIGURE 7. Setup Time, Hold Time and Recovery Time Waveforms



Physical Dimensions inches (millimeters) unless otherwise noted



E20A (REV D)

20-Terminal Ceramic Chip Carrier (L)
 NS Package Number E20A

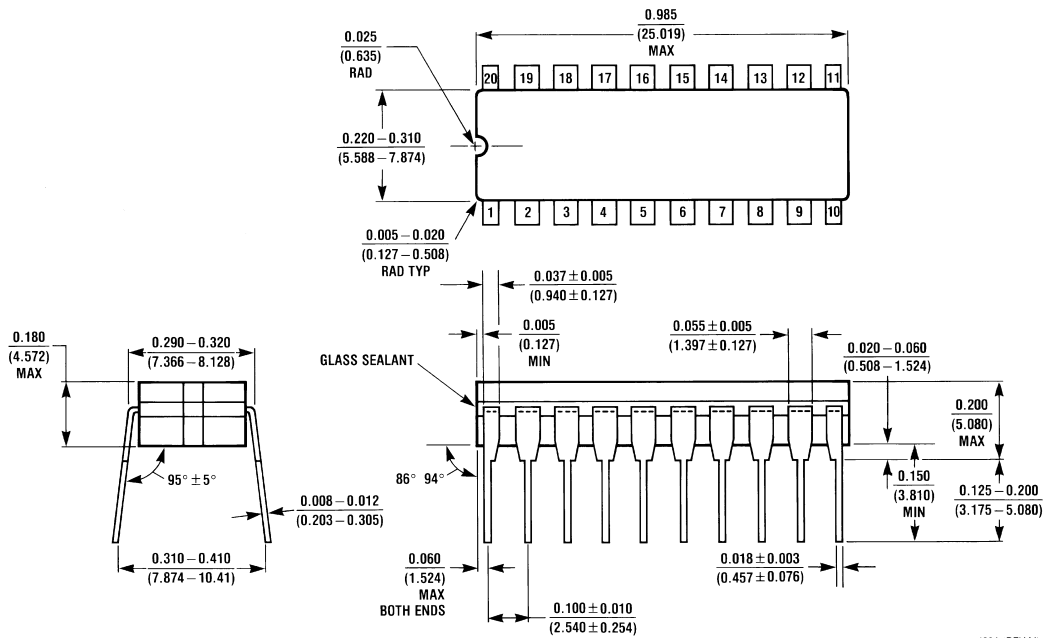

J20A (REV M)

20-Lead Ceramic Dual-In-Line (D)
 NS Package Number J20A

Physical Dimensions inches (millimeters) unless otherwise noted (Continued)

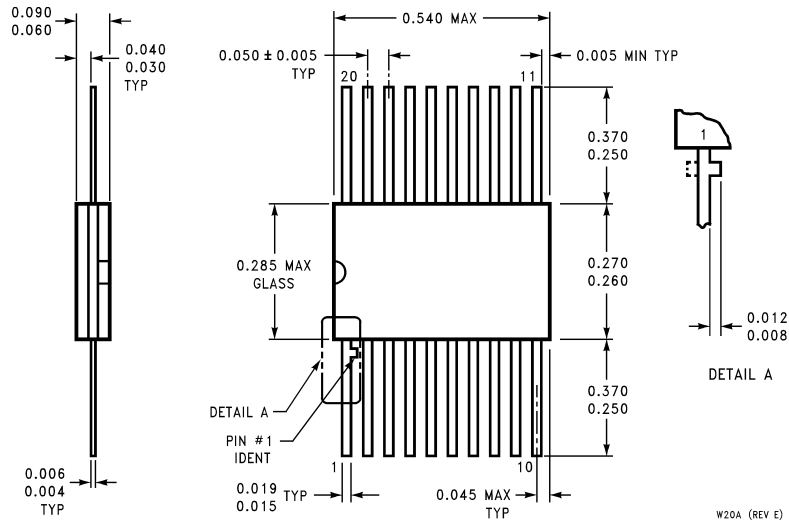

**20-Lead Ceramic Flatpak (F)
NS Package Number W20A**

LIFE SUPPORT POLICY

NATIONAL'S PRODUCTS ARE NOT AUTHORIZED FOR USE AS CRITICAL COMPONENTS IN LIFE SUPPORT DEVICES OR SYSTEMS WITHOUT THE EXPRESS WRITTEN APPROVAL OF THE PRESIDENT OF NATIONAL SEMICONDUCTOR CORPORATION. As used herein:

1. Life support devices or systems are devices or systems which, (a) are intended for surgical implant into the body, or (b) support or sustain life, and whose failure to perform when properly used in accordance with instructions for use provided in the labeling, can be reasonably expected to result in a significant injury to the user.
2. A critical component in any component of a life support device or system whose failure to perform can be reasonably expected to cause the failure of the life support device or system, or to affect its safety or effectiveness.



National Semiconductor Corporation
Americas
Tel: 1-800-272-9959
Fax: 1-800-737-7018
Email: support@nsc.com

National Semiconductor Europe
Fax: +49 (0) 1 80-530 85 86
Email: europe.support@nsc.com
Deutsch Tel: +49 (0) 1 80-530 85 85
English Tel: +49 (0) 1 80-532 78 32
Français Tel: +49 (0) 1 80-532 93 58
Italiano Tel: +49 (0) 1 80-534 16 80

National Semiconductor Asia Pacific Customer Response Group
Tel: 65-2544466
Fax: 65-2504466
Email: sea.support@nsc.com

National Semiconductor Japan Ltd.
Tel: 81-3-5620-6175
Fax: 81-3-5620-6179

www.national.com