

## General Purpose NPN Transistor Arrays

November 1996

### Features

- **Two Matched Transistors**
  - $V_{BE}$  Match .....  $\pm 5mV$
  - $I_{IO}$  Match .....  $2\mu A$  (Max)
- **Low Noise Figure** .....  $3.2dB$  (Typ) at  $1kHz$
- **5 General Purpose Monolithic Transistors**
- **Operation From DC to 120MHz**
- **Wide Operating Current Range**
- **Full Military Temperature Range**

### Applications

- **Three Isolated Transistors and One Differentially Connected Transistor Pair for Low Power Applications at Frequencies from DC Through the VHF Range**
- **Custom Designed Differential Amplifiers**
- **Temperature Compensated Amplifiers**
- **See Application Note, AN5296 "Application of the CA3018 Integrated-Circuit Transistor Array" for Suggested Applications**

### Description

The CA3045 and CA3046 each consist of five general purpose silicon NPN transistors on a common monolithic substrate. Two of the transistors are internally connected to form a differentially connected pair.

The transistors of the CA3045 and CA3046 are well suited to a wide variety of applications in low power systems in the DC through VHF range. They may be used as discrete transistors in conventional circuits. However, in addition, they provide the very significant inherent integrated circuit advantages of close electrical and thermal matching.

### Ordering Information

| PART NUMBER (BRAND) | TEMP. RANGE (°C) | PACKAGE                  | PKG. NO. |
|---------------------|------------------|--------------------------|----------|
| CA3045              | -55 to 125       | 14 Ld SBDIP              | D14.3    |
| CA3045F             | -55 to 125       | 14 Ld CERDIP             | F14.3    |
| CA3046              | -55 to 125       | 14 Ld PDIP               | E14.3    |
| CA3046M (3046)      | -55 to 125       | 14 Ld SOIC               | M14.15   |
| CA3046M96 (3046)    | -55 to 125       | 14 Ld SOIC Tape and Reel | M14.15   |

### Pinout

CA3045, (CERDIP, SBDIP)  
CA3046 (PDIP, SOIC)  
TOP VIEW

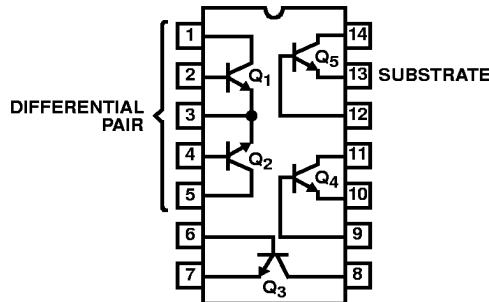

## CA3045, CA3046

### Absolute Maximum Ratings

|                                                      |      |
|------------------------------------------------------|------|
| Collector-to-Emitter Voltage ( $V_{CEO}$ )           | 15V  |
| Collector-to-Base Voltage ( $V_{CBO}$ )              | 20V  |
| Collector-to-Substrate Voltage ( $V_{CIO}$ ; Note 1) | 20V  |
| Emitter-to-Base Voltage ( $V_{EBO}$ )                | 5V   |
| Collector Current ( $I_C$ )                          | 50mA |

### Operating Conditions

|                   |                |
|-------------------|----------------|
| Temperature Range | -55°C to 125°C |
|-------------------|----------------|

### Thermal Information

|                                                  |                         |                      |
|--------------------------------------------------|-------------------------|----------------------|
| Thermal Resistance (Typical, Note 2)             | $\theta_{JA}$ (°C/W)    | $\theta_{JC}$ (°C/W) |
| PDIP Package                                     | 180                     | N/A                  |
| CERDIP Package                                   | 150                     | 75                   |
| SBDIP Package                                    | 125                     | 60                   |
| SOIC Package                                     | 220                     | N/A                  |
| Maximum Power Dissipation (Any One Transistor)   | 300mW                   |                      |
| Maximum Junction Temperature (Hermetic Packages) | 175°C                   |                      |
| Maximum Junction Temperature (Plastic Package)   | 150°C                   |                      |
| Maximum Storage Temperature Range                | -65°C to 150°C          |                      |
| Maximum Lead Temperature (Soldering 10s)         | 300°C                   |                      |
|                                                  | (SOIC - Lead Tips Only) |                      |

**CAUTION:** Stresses above those listed in "Absolute Maximum Ratings" may cause permanent damage to the device. This is a stress only rating and operation of the device at these or any other conditions above those indicated in the operational sections of this specification is not implied.

### NOTES:

- The collector of each transistor of the CA3045 and CA3046 is isolated from the substrate by an integral diode. The substrate (Terminal 13) must be connected to the most negative point in the external circuit to maintain isolation between transistors and to provide for normal transistor action.
- $\theta_{JA}$  is measured with the component mounted on an evaluation PC board in free air.

### Electrical Specifications $T_A = 25^\circ\text{C}$ , characteristics apply for each transistor in CA3045 and CA3046 as specified

| PARAMETER                                                                                                                                                | SYMBOL                           | TEST CONDITIONS                           | MIN                   | TYP        | MAX   | UNITS                        |   |
|----------------------------------------------------------------------------------------------------------------------------------------------------------|----------------------------------|-------------------------------------------|-----------------------|------------|-------|------------------------------|---|
| <b>DC CHARACTERISTICS</b>                                                                                                                                |                                  |                                           |                       |            |       |                              |   |
| Collector-to-Base Breakdown Voltage                                                                                                                      | $V_{(BR)CBO}$                    | $I_C = 10\mu\text{A}$ , $I_E = 0$         | 20                    | 60         | -     | V                            |   |
| Collector-to-Emitter Breakdown Voltage                                                                                                                   | $V_{(BR)CEO}$                    | $I_C = 1\text{mA}$ , $I_B = 0$            | 15                    | 24         | -     | V                            |   |
| Collector-to-Substrate Breakdown Voltage                                                                                                                 | $V_{(BR)CIO}$                    | $I_C = 10\mu\text{A}$ , $I_{C1} = 0$      | 20                    | 60         | -     | V                            |   |
| Emitter-to-Base Breakdown Voltage                                                                                                                        | $V_{(BR)EBO}$                    | $I_E = 10\mu\text{A}$ , $I_C = 0$         | 5                     | 7          | -     | V                            |   |
| Collector Cutoff Current (Figure 1)                                                                                                                      | $I_{CBO}$                        | $V_{CB} = 10\text{V}$ , $I_E = 0$         | -                     | 0.002      | 40    | nA                           |   |
| Collector Cutoff Current (Figure 2)                                                                                                                      | $I_{CEO}$                        | $V_{CE} = 10\text{V}$ , $I_B = 0$         | -                     | See Fig. 2 | 0.5   | $\mu\text{A}$                |   |
| Forward Current Transfer Ratio (Static Beta) (Note 3) (Figure 3)                                                                                         | $h_{FE}$                         | $V_{CE} = 3\text{V}$                      | $I_C = 10\text{mA}$   | -          | 100   | -                            | - |
|                                                                                                                                                          |                                  |                                           | $I_C = 1\text{mA}$    | 40         | 100   | -                            | - |
|                                                                                                                                                          |                                  |                                           | $I_C = 10\mu\text{A}$ | -          | 54    | -                            | - |
| Input Offset Current for Matched Pair $Q_1$ and $Q_2$ : $ I_{O1} - I_{O2} $ (Note 3) (Figure 4)                                                          |                                  | $V_{CE} = 3\text{V}$ , $I_C = 1\text{mA}$ | -                     | 0.3        | 2     | $\mu\text{A}$                |   |
| Base-to-Emitter Voltage (Note 3) (Figure 5)                                                                                                              | $V_{BE}$                         | $V_{CE} = 3\text{V}$                      | $I_E = 1\text{mA}$    | -          | 0.715 | -                            | V |
|                                                                                                                                                          |                                  |                                           | $I_E = 10\text{mA}$   | -          | 0.800 | -                            | V |
| Magnitude of Input Offset Voltage for Differential Pair $ V_{BE1} - V_{BE2} $ (Note 3) (Figures 5, 7)                                                    |                                  | $V_{CE} = 3\text{V}$ , $I_C = 1\text{mA}$ | -                     | 0.45       | 5     | mV                           |   |
| Magnitude of Input Offset Voltage for Isolated Transistors $ V_{BE3} - V_{BE4} $ , $ V_{BE4} - V_{BE5} $ , $ V_{BE5} - V_{BE3} $ (Note 3) (Figures 5, 7) |                                  | $V_{CE} = 3\text{V}$ , $I_C = 1\text{mA}$ | -                     | 0.45       | 5     | mV                           |   |
| Temperature Coefficient of Base-to-Emitter Voltage (Figure 6)                                                                                            | $\frac{\Delta V_{BE}}{\Delta T}$ | $V_{CE} = 3\text{V}$ , $I_C = 1\text{mA}$ | -                     | -1.9       | -     | $\text{mV}/^\circ\text{C}$   |   |
| Collector-to-Emitter Saturation Voltage                                                                                                                  | $V_{CES}$                        | $I_B = 1\text{mA}$ , $I_C = 10\text{mA}$  | -                     | 0.23       | -     | V                            |   |
| Temperature Coefficient: Magnitude of Input Offset Voltage (Figure 7)                                                                                    | $\frac{\Delta V_{IO}}{\Delta T}$ | $V_{CE} = 3\text{V}$ , $I_C = 1\text{mA}$ | -                     | 1.1        | -     | $\mu\text{V}/^\circ\text{C}$ |   |

# CA3045, CA3046

## Electrical Specifications $T_A = 25^\circ\text{C}$ , characteristics apply for each transistor in CA3045 and CA3046 as specified (Continued)

| PARAMETER                                                      | SYMBOL   | TEST CONDITIONS                                                                                              | MIN | TYP                  | MAX | UNITS            |
|----------------------------------------------------------------|----------|--------------------------------------------------------------------------------------------------------------|-----|----------------------|-----|------------------|
| <b>DYNAMIC CHARACTERISTICS</b>                                 |          |                                                                                                              |     |                      |     |                  |
| Low Frequency Noise Figure (Figure 9)                          | NF       | $f = 1\text{kHz}$ , $V_{CE} = 3\text{V}$ , $I_C = 100\mu\text{A}$ ,<br>Source Resistance = $1\text{k}\Omega$ | -   | 3.25                 | -   | dB               |
| Low Frequency, Small Signal Equivalent Circuit Characteristics |          |                                                                                                              |     |                      |     |                  |
| Forward Current Transfer Ratio (Figure 11)                     | $h_{FE}$ | $f = 1\text{kHz}$ , $V_{CE} = 3\text{V}$ , $I_C = 1\text{mA}$                                                | -   | 110                  | -   | -                |
| Short Circuit Input Impedance (Figure 11)                      | $h_{iE}$ | $f = 1\text{kHz}$ , $V_{CE} = 3\text{V}$ , $I_C = 1\text{mA}$                                                | -   | 3.5                  | -   | $\text{k}\Omega$ |
| Open Circuit Output Impedance (Figure 11)                      | $h_{oE}$ | $f = 1\text{kHz}$ , $V_{CE} = 3\text{V}$ , $I_C = 1\text{mA}$                                                | -   | 15.6                 | -   | $\mu\text{S}$    |
| Open Circuit Reverse Voltage Transfer Ratio (Figure 11)        | $h_{rE}$ | $f = 1\text{kHz}$ , $V_{CE} = 3\text{V}$ , $I_C = 1\text{mA}$                                                | -   | $1.8 \times 10^{-4}$ | -   | -                |
| Admittance Characteristics                                     |          |                                                                                                              |     |                      |     |                  |
| Forward Transfer Admittance (Figure 12)                        | $Y_{FE}$ | $f = 1\text{kHz}$ , $V_{CE} = 3\text{V}$ , $I_C = 1\text{mA}$                                                | -   | $31 - j1.5$          | -   | -                |
| Input Admittance (Figure 13)                                   | $Y_{iE}$ | $f = 1\text{kHz}$ , $V_{CE} = 3\text{V}$ , $I_C = 1\text{mA}$                                                | -   | $0.3 + j0.04$        | -   | -                |
| Output Admittance (Figure 14)                                  | $Y_{oE}$ | $f = 1\text{kHz}$ , $V_{CE} = 3\text{V}$ , $I_C = 1\text{mA}$                                                | -   | $0.001 + j0.03$      | -   | -                |
| Reverse Transfer Admittance (Figure 15)                        | $Y_{rE}$ | $f = 1\text{kHz}$ , $V_{CE} = 3\text{V}$ , $I_C = 1\text{mA}$                                                | -   | See Fig. 14          | -   | -                |
| Gain Bandwidth Product (Figure 16)                             | $f_T$    | $V_{CE} = 3\text{V}$ , $I_C = 3\text{mA}$                                                                    | 300 | 550                  | -   | MHz              |
| Emitter-to-Base Capacitance                                    | $C_{EB}$ | $V_{EB} = 3\text{V}$ , $I_E = 0$                                                                             | -   | 0.6                  | -   | pF               |
| Collector-to-Base Capacitance                                  | $C_{CB}$ | $V_{CB} = 3\text{V}$ , $I_C = 0$                                                                             | -   | 0.58                 | -   | pF               |
| Collector-to-Substrate Capacitance                             | $C_{CI}$ | $V_{CS} = 3\text{V}$ , $I_C = 0$                                                                             | -   | 2.8                  | -   | pF               |

NOTE:

3. Actual forcing current is via the emitter for this test.

## Typical Performance Curves

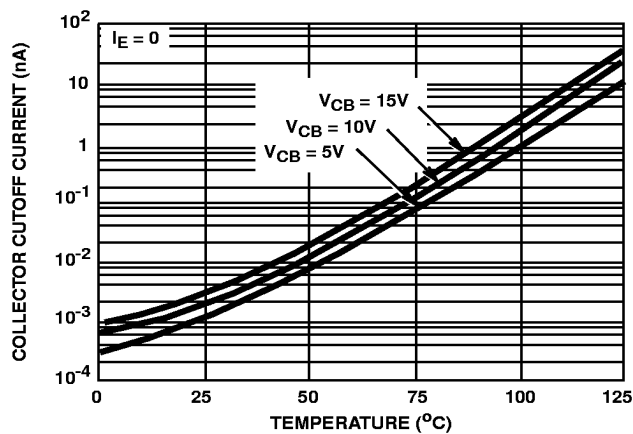

FIGURE 1. TYPICAL COLLECTOR-TO-BASE CUTOFF CURRENT vs TEMPERATURE FOR EACH TRANSISTOR

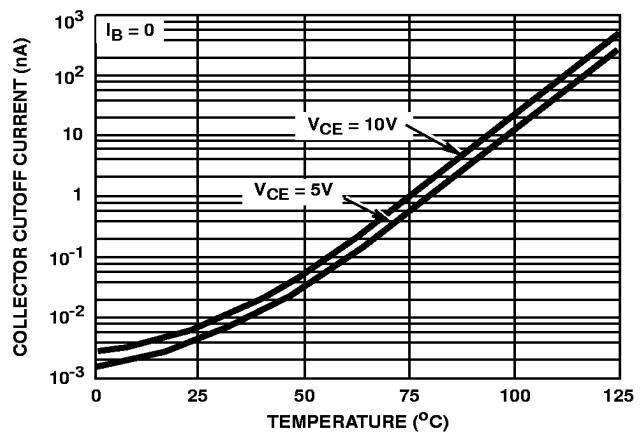

FIGURE 2. TYPICAL COLLECTOR-TO-EMITTER CUTOFF CURRENT vs TEMPERATURE FOR EACH TRANSISTOR

Typical Performance Curves (Continued)

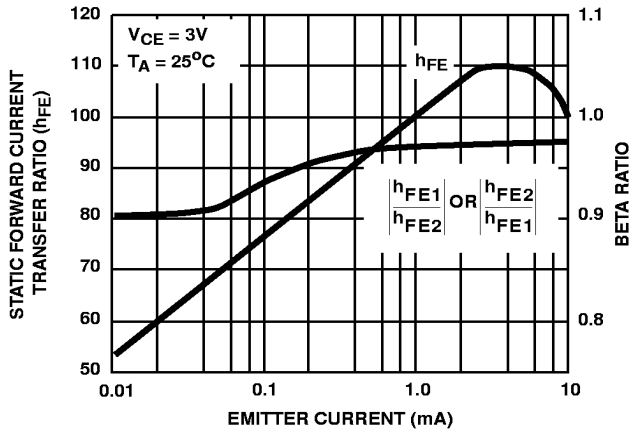

FIGURE 3. TYPICAL STATIC FORWARD CURRENT TRANSFER RATIO AND BETA RATIO FOR Q<sub>1</sub> AND Q<sub>2</sub> vs EMITTER CURRENT

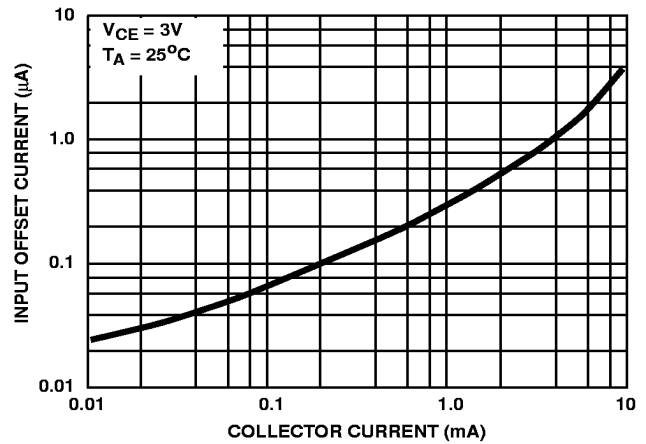

FIGURE 4. TYPICAL INPUT OFFSET CURRENT FOR MATCHED TRANSISTOR PAIR Q<sub>1</sub>Q<sub>2</sub> vs COLLECTOR CURRENT

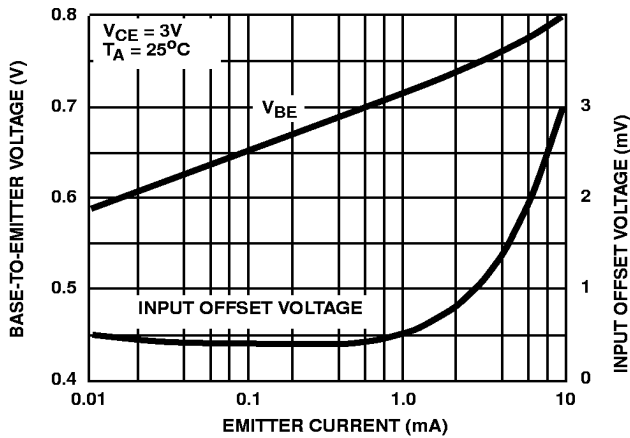

FIGURE 5. TYPICAL STATIC BASE-TO-EMITTER VOLTAGE CHARACTERISTICS AND INPUT OFFSET VOLTAGE FOR DIFFERENTIAL PAIR AND PAIRED ISOLATED TRANSISTORS vs EMITTER CURRENT

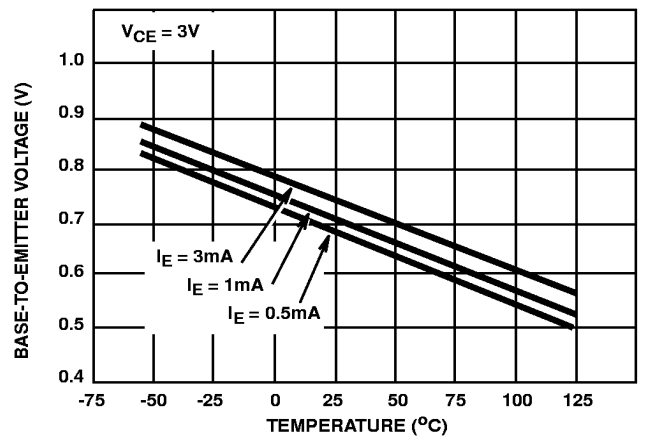

FIGURE 6. TYPICAL BASE-TO-EMITTER VOLTAGE CHARACTERISTIC vs TEMPERATURE FOR EACH TRANSISTOR

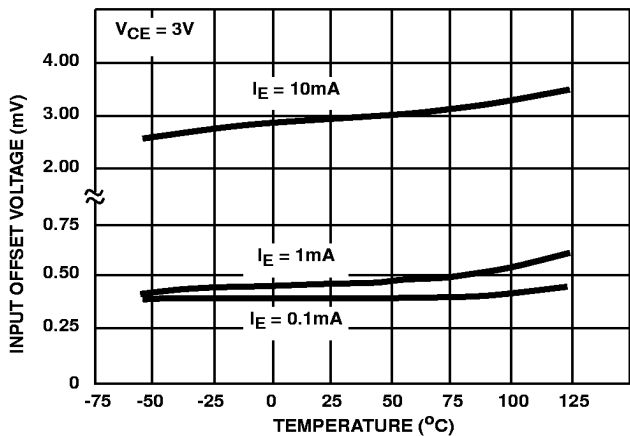

FIGURE 7. TYPICAL INPUT OFFSET VOLTAGE CHARACTERISTICS FOR DIFFERENTIAL PAIR AND PAIRED ISOLATED TRANSISTORS vs TEMPERATURE

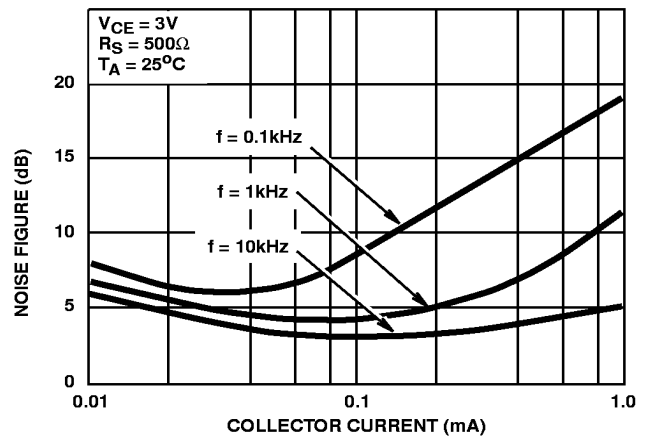

FIGURE 8. TYPICAL NOISE FIGURE vs COLLECTOR CURRENT

Typical Performance Curves (Continued)

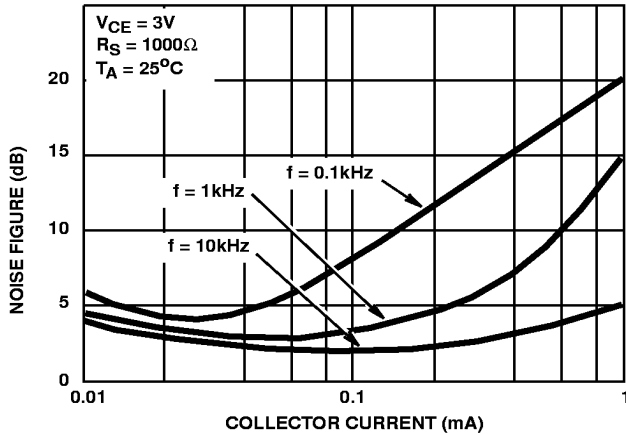

FIGURE 9. TYPICAL NOISE FIGURE vs COLLECTOR CURRENT

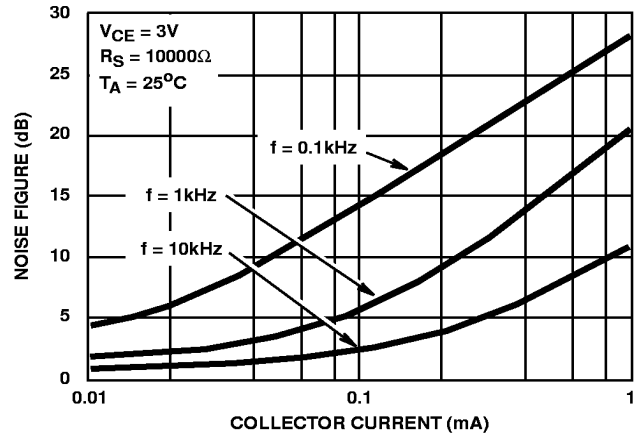

FIGURE 10. TYPICAL NOISE FIGURE vs COLLECTOR CURRENT

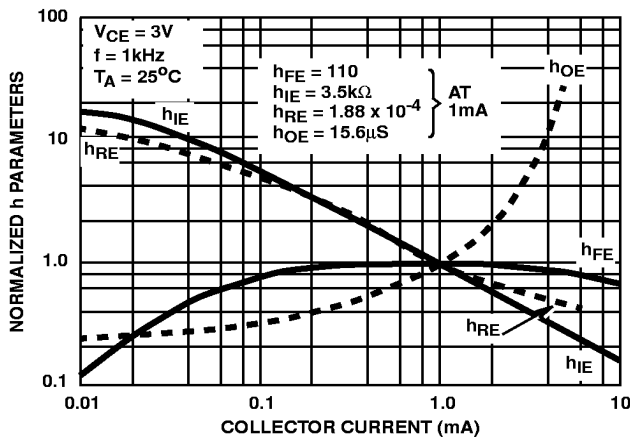

FIGURE 11. TYPICAL NORMALIZED FORWARD CURRENT TRANSFER RATIO, SHORT CIRCUIT INPUT IMPEDANCE, OPEN CIRCUIT OUTPUT IMPEDANCE, AND OPEN CIRCUIT REVERSE VOLTAGE TRANSFER RATIO vs COLLECTOR CURRENT

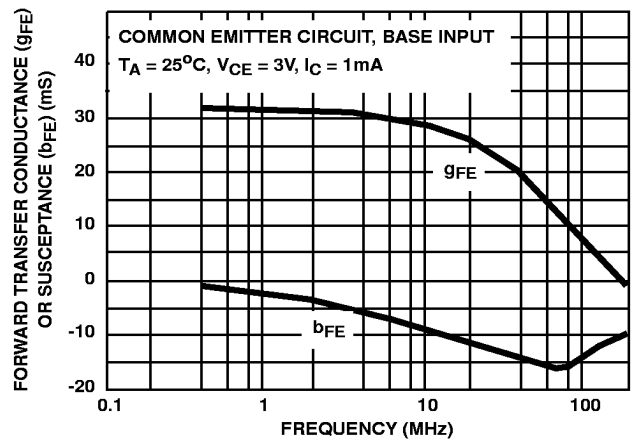

FIGURE 12. TYPICAL FORWARD TRANSFER ADMITTANCE vs FREQUENCY

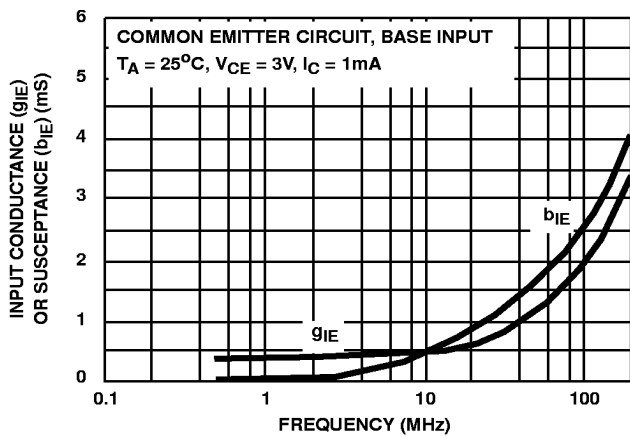

FIGURE 13. TYPICAL INPUT ADMITTANCE vs FREQUENCY

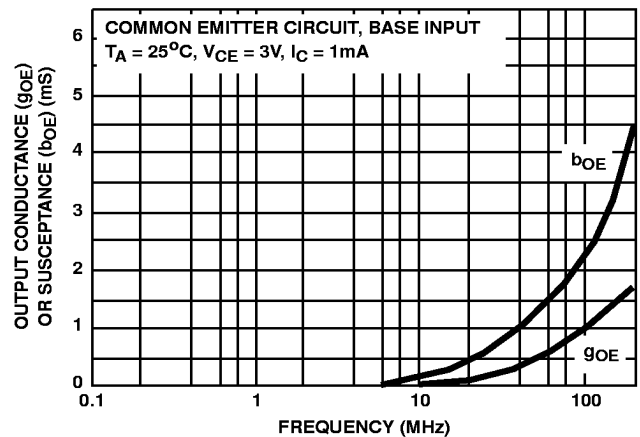

FIGURE 14. TYPICAL OUTPUT ADMITTANCE vs FREQUENCY

Typical Performance Curves (Continued)

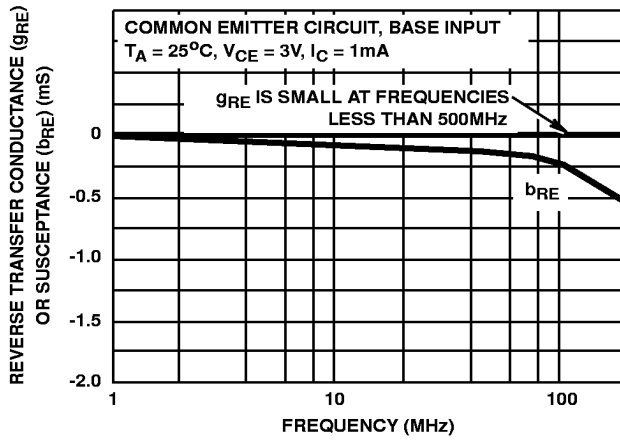

FIGURE 15. TYPICAL REVERSE TRANSFER ADMITTANCE vs FREQUENCY

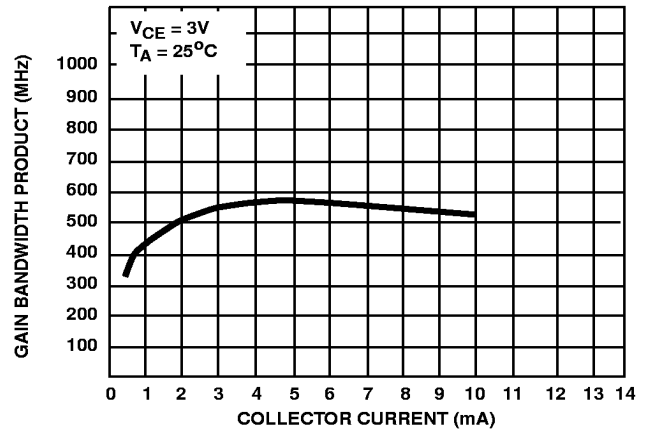

FIGURE 16. TYPICAL GAIN BANDWIDTH PRODUCT vs COLLECTOR CURRENT